



## REGIONAL EMERGENCY MANAGEMENT PLAN



May 2021

# Table of Contents

<b>1.0</b>	<b>INTRODUCTION</b>	<b>1</b>
1.1	Geographical Profile	1
1.2	Regional Approach	1
1.3	Emergency Management Legislation	1
1.3.1	Federal	1
1.3.2	Provincial	1
1.3.3	Municipal	2
<b>2.0</b>	<b>OBJECTIVES OF EMERGENCY MANAGEMENT</b>	<b>4</b>
2.1	Objective 1 – Assess Risks	4
2.2	Objective 2 – Mitigate Risks	4
2.3	Objective 3 – Plan for Response	5
2.4	Objective 4 – Plan for Recovery	5
2.5	Objective 5 – Ensure Preparedness	5
2.6	Objective 6 – Evaluate and Renew the Program	5
<b>3.0</b>	<b>EMERGENCY PLAN STRUCTURE</b>	<b>6</b>
3.1	Scope	6
3.2	Purpose	6
3.3	Authority	6
<b>4.0</b>	<b>THEORY OF OPERATION</b>	<b>6</b>
4.1	Presumptions	7
4.1.1	Incident Presumptions	7
4.1.2	Plan Presumptions	8
4.2	Plan Activation	8
4.2.1	ECC Activation Levels	9
4.2.1.1	Level 1 – Full Activation (All Personnel)	11
4.2.1.2	Level 2 – Partial Activation (Key Personnel and Personnel from Responding Agencies)	12
4.2.1.3	Level 3 – Monitoring (Key Personnel Only)	13
4.2.2	Deactivation	13
<b>5.0</b>	<b>HAZARD IDENTIFICATION AND RISK ANALYSIS (HIRA)</b>	<b>14</b>
5.1	Regional Hazard Analysis	14
5.1.1	Hurricane/Blizzard/Ice Storm	14
5.1.2	Power Failures	15

5.1.3	Wildland Fires .....	15
5.1.4	Flood .....	15
5.1.5	Highway Closures .....	15
5.1.6	Major Transportation Accidents .....	15
5.1.7	Extreme Heat .....	15
5.1.8	Water Shortages/Major Water Main Breaks .....	16
5.1.9	Epidemic/ Pandemic.....	16
5.1.10	Communication Failures .....	16
5.2	Risk Analysis Matrix .....	17
5.3	Hazard and Risk Mitigation .....	19
5.3.1	Blizzards .....	19
5.3.2	Hurricanes.....	20
5.3.3	Floods.....	20
5.4	Business Impact Analysis .....	21
5.4.1	Preparedness Level.....	21
5.4.2	Severe Weather Notifications and Alerting .....	21
5.4.3	Communications – Radio, Telephone, Satellite Phone and Mass Notification Software	22
5.4.4	Communications – Truro Amateur Radio Club (TARC).....	22
5.4.5	Capacity to Respond to Casualties and Damage .....	22
5.4.6	Water Distribution .....	23
5.4.7	Water Distribution and Consumption – Livestock .....	24
5.4.8	Sewer Collection and Treatment .....	24
5.4.9	Public Works Staff .....	24
5.4.10	Nova Scotia Department of Transportation and Infrastructural Renewal (NSTIR).....	25
5.4.11	Nova Scotia Power (NSP) .....	25
5.4.12	Other Critical Infrastructure.....	25
<b>6.0</b>	<b>EVACUATION .....</b>	<b>26</b>
6.1	Evacuee Alerting and Sheltering.....	26
6.2	Evacuation Process.....	27
<b>7.0</b>	<b>REGIONAL EMERGENCY MANAGEMENT ORGANIZATION (REMO).....</b>	<b>27</b>
7.1	Regional Emergency Management Advisory Committee (REMAC).....	27
7.2	Regional Emergency Management Planning Committee (REMPC) .....	28
<b>8.0</b>	<b>RESOURCE REQUIREMENTS AND LOGISTICAL SUPPORT .....</b>	<b>29</b>

<b>8.1</b>	<b>States of Emergency</b> .....	<b>29</b>
8.1.1	Declaration of a State of Local Emergency .....	29
8.1.2	Renewal of a State of Local Emergency .....	29
8.1.3	Termination of a State of Local Emergency .....	29
<b>8.2</b>	<b>Communications</b> .....	<b>30</b>
8.2.1	Emergency Communications Plan .....	30
8.2.2	Emergency Public Information Plan.....	30
<b>8.3</b>	<b>Emergency Coordination Centre (ECC)</b> .....	<b>31</b>
8.3.1	ECC Principal Tasks .....	32
<b>8.4</b>	<b>Volunteers</b> .....	<b>33</b>
<b>9.0</b>	<b>PLAN EVALUATION, REVIEW and MAINTENANCE</b> .....	<b>34</b>
9.1	Plan Evaluation and Responsibilities .....	34
9.2	Plan Maintenance and Responsibility .....	34
<b>10.0</b>	<b>PLAN DISTRIBUTION</b> .....	<b>35</b>
<b>ANNEXES</b> .....	<b>A</b>	
Annex A – List of Acronyms .....	A	
Annex B – List of Definitions .....	D	
Annex C – ECC Activation Guideline .....	G	
Annex D – ECC Roles and Responsibilities .....	H	
Annex E – Evacuation Considerations .....	R	
Annex F – Potential Evacuation Routes – Central Colchester Flood Risk Areas.....	T	
Annex G – Emergency Public Information Plan.....	U	
Annex H – State of Local Emergency Forms (SOLE).....	Z	
Annex I – Important Numbers .....	EE	



COLCHESTER REGIONAL  
**EMO**

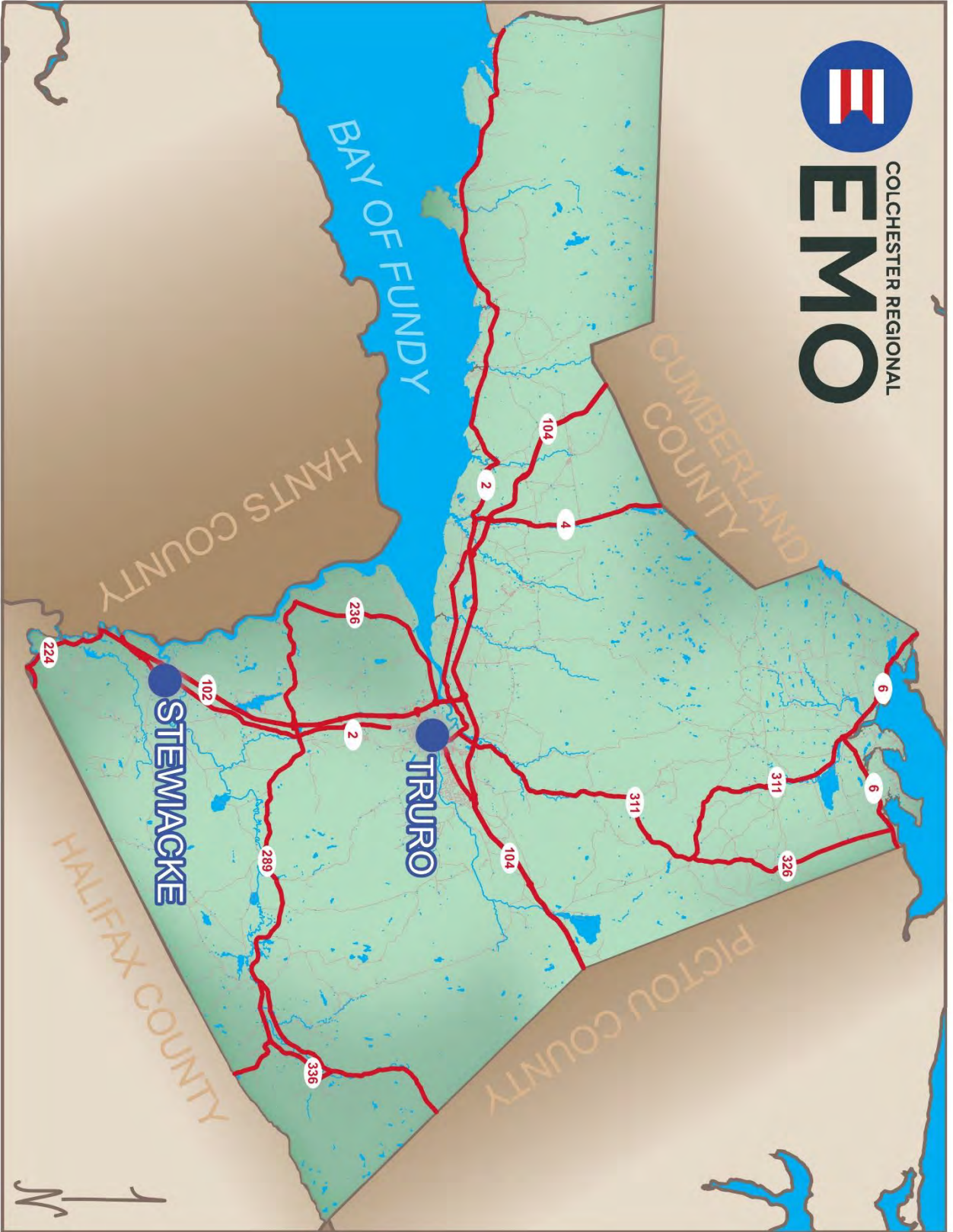

## 1.0 INTRODUCTION

### 1.1 Geographical Profile

Colchester County is comprised of 3628 km<sup>2</sup> with a population of 50,585 (2016 Census Data from Statistics Canada). The region is located centrally in Nova Scotia abutting the Northumberland Strait and the Minas Basin in the Bay of Fundy as well as bordering the Halifax Regional Municipality, Pictou, and Cumberland Counties and the Municipality of East Hants. Within the County there are the Towns of Stewiacke and Truro along with the First Nation community of Millbrook and the Municipality of Colchester. As well, within the Municipality of Colchester there are the Villages of Bible Hill and Tatamagouche.

The County is a region that has a vibrant industrial, manufacturing, agricultural, commercial, residential community that has its strength in its residents.

### 1.2 Regional Approach

All municipalities in Nova Scotia have the potential to be affected by any number of both natural and manmade disasters or emergencies and our region echoes that statement. With our region's substantial transport network, susceptibility to sea level rise, abundant forested areas, historical flood plains and central geographical location, Colchester County's municipalities have agreed to a regional approach for their responses to disasters and emergencies. The coordinated regional approach allows for effective sharing of essential information with internal and external stakeholders, the community, and the media to have a successful response and organized recovery from the disaster or emergency.

This Regional Emergency Management Plan was solely developed for Colchester County to include the Towns of Stewiacke and Truro and the Municipality of Colchester. The plan was not created or intended to replace protocols or procedures for managing the normal day to day common occurrences that are managed routinely by Emergency Services and/or municipal departments. The plan does, however, outline the responsibilities, designates duties, and directs the actions of key personnel.

### 1.3 Emergency Management Legislation

#### 1.3.1 Federal

Public Safety Canada is responsible for the national emergency management system and in the event that there is a nationally declared emergency, the federal government may or will activate its Federal Emergency Response Plan and it will coordinate emergency management activities among government institutions and in cooperation with the provinces and territories through their regional offices.

#### 1.3.2 Provincial

The Province of Nova Scotia is responsible for the provincial emergency management that ensures the safety of all Nova Scotians through the Emergency Management Act. The Act provides the Minister of Emergency Management the authority over all matters respecting emergency planning, preparedness, response, mitigation, recovery for emergencies in the Province. The Emergency Management Office (EMO) has and shall exercise and perform such powers and duties as are assigned in it by or under this Act and those assigned to it by the Minister. EMO may, subject to the approval of the Minister:

- a) Review and approve, or require modification to the Provincial and municipal emergency management plans;

- b) Make surveys and studies to identify and record actual and potential hazards that may cause an emergency;
- c) Make surveys and studies of resources and facilities to provide information for the effective preparation of emergency management plans;
- d) Conduct public information programs related to the prevention and mitigation of damage during an emergency;
- e) Conduct training and training exercises for the effective implementation of emergency management plans;
- f) Procure food, clothing, medicines, equipment and goods of any nature or kind for the purposes of emergencies;
- g) Authorize or require the implementation of any emergency management plan;
- h) Enter into agreements with any persons or organizations or associations in respect of emergency management plans.

Additionally, the Minister may:

- a) Divide the Province into districts and subdistricts for the purpose of this Act;
- b) After consultation with the municipalities concerned, designate a combination of municipalities or parts thereof as a municipality for the purpose of this Act and determine the respective responsibilities of municipalities in the designated area;
- c) Require municipalities to prepare emergency management plans, including mutual aid programs, and to submit such plans to the Department for review for adequacy and integration with Provincial emergency management plans;
- d) Establish procedures for the prompt and efficient implementation of emergency management plans;
- e) Require any person to develop emergency management plans in conjunction with the Department or the municipalities to remedy or alleviate any hazard to persons or property.

The Minister, after consulting, if it practical to do so, with a majority of the members of a committee established pursuant to Section 5 or a quorum of the Executive Council and, if the Minister is satisfied that an emergency exists or may exist, may declare a state of emergency in respect of all or any district. Subdistrict or area of the Province.

### 1.3.3 Municipal

Within the Provincial Emergency Management Act, the Minister has delegated responsibilities to all municipalities within one year after the coming into force the Act, each municipality shall:

- a) Subject to the approval of the Minister, establish and maintain a municipal emergency bylaw;



Municipality of Colchester  
Town of Truro  
Town of Stewiacke

Bylaw Number 42 dated: March 26, 2015  
Bylaw Number B100-006 dated: November 4, 2013  
Bylaw Number 2007-07 dated: November 28, 2013

- b) Establish and maintain a municipal emergency management organization;
- c) Appoint a coordinator of the municipal emergency management organization and prescribe the duties of the coordinator which shall include the preparation and coordination of emergency management plans for the municipality;
- d) Appoint a committee consisting of members of the municipal council to advise it on the development of emergency management plans; and
- e) Prepare and approve emergency management plans.

The Municipality may:

- a) Pay the reasonable expenses of members of the organization or members of the committee appointed;
- b) Enter into agreements with and make payments to persons and organizations for the provision of services in the development and implementation of emergency management plans;
- c) Enter into arrangements or agreement with any other municipality respecting a common organization, plan or program;
- d) Appropriate and expend sums approved by it for purpose of this section; and
- e) Every municipality shall immediately upon becoming aware of it, inform the Department of any real or anticipated event or emergency that could impact the health, safety or welfare of Nova Scotians, their property, or the environment.



## 2.0 OBJECTIVES OF EMERGENCY MANAGEMENT

In establishing and maintaining our Emergency Response Plan, six core objectives have been identified.



### 2.1 Objective 1 – Assess Risks

The objective of assessing risks through the Hazard Identification and Risk Analysis (HIRA) process helps to assess the potential risk of hazards with the capacity to cause a disaster. The HIRA helps set priorities for prevention, mitigation, preparedness, response, and recovery, as well as it directs the greatest effort to the greatest need.

To determine what resources are critical to the delivery of essential Municipal services, it is required that a basic Business Impact Analysis (BIA) be conducted. In the event a piece of infrastructure required for the delivery of critical municipal services is lost due to an emergency, the BIA will provide some guidance in determining the Municipality's response.

### 2.2 Objective 2 – Mitigate Risks

Mitigation measures are designed to prevent or reduce the consequences of emergencies. Measures include:

- Building codes
- Land use management
- Public education
- Insurance incentives

These measures fall generally under responsibilities of various legislative bodies and public safety agencies. Recent municipal flood mitigation programs may have lessened disastrous floods, but they along with weather extremes cannot be prevented and demand efforts in mitigation, response, and recovery.

### 2.3 Objective 3 – Plan for Response

In addition to the developing the emergency plans there are other planning tasks that need to be considered:

- Identification of vulnerable populations
- Identifying and designating emergency support facilities

Planning for response includes:

- Establishing an emergency coordination centre
- Identifying resources
- Preparing to issue warnings
- Planning for evacuation

Primary measures are the development of emergency plans and resources inventories.

### 2.4 Objective 4 – Plan for Recovery

Recovery includes the physical restoration and reconstruction following a disaster. Actions may include:

- The re-introduction of displaced persons
- Economic impact estimates
- Counselling
- Financial assistance programs
- Temporary housing
- Health and safety information

### 2.5 Objective 5 – Ensure Preparedness

Preparedness actions ensure that individuals and both public and private agencies will be ready to react effectively in an emergency utilizing the below measures:

- Gathering equipment required to provide site support
- Individual and collective training
- Exercising members of the Emergency Management Committee. Actions are wide-ranging with emphasis on coordination and training

### 2.6 Objective 6 – Evaluate and Renew the Program

The Emergency Management Committee will periodically evaluate the entire Emergency Management Program, by measuring the performance of selected actions and the achievement of desired results.

## 3.0 EMERGENCY PLAN STRUCTURE

### 3.1 Scope

The goal of the Colchester Regional Emergency Management Plan (REMP) is to provide the context within which extraordinary measures can be taken to protect the health, safety, and welfare of the residents, prevent or minimize property damage or loss, protect the environment, and minimize economic disruption when faced with an emergency.

For the Plan to be effective, it is necessary for staff to take advantage of emergency management courses to understand the Incident Command System (ICS) and the roles and responsibilities of staff working in the Emergency Coordination Centre. ICS training throughout the Colchester County will be coordinated by the Regional Emergency Management Coordinator (REMC).

### 3.2 Purpose

The Colchester Regional Emergency Plan merges the efforts of Colchester County resources for a comprehensive approach in responding to and lessening the impacts of an emergency. It is intended to increase the emergency response capacity across all of Colchester County by establishing a plan of action to deploy required resources effectively and efficiently.

The purpose of this REMP is to provide for the needs our citizens whenever they are threatened or experience a catastrophic severe weather event or an incident resulting from flood, fire, spill or other emergency that places our citizens in danger.

### 3.3 Authority

The Colchester Regional Emergency Plan was designed and developed in accordance with best practice provided by EMO Nova Scotia and the Inter-Municipal Emergency Services Agreement between the Municipality of Colchester and the Towns of Truro and Stewiacke.

Any incident that necessitates an evacuation of as little as 25 people or 10 building units may activate a response to the scene by Colchester Regional Emergency Management Coordinator (REMC) to meet with the Incident Commander to determine the appropriate level of activation required by this Plan. The decision to activate the Emergency Coordination Centre (ECC) to support the Incident Commander on scene for support staff will be at the discretion of the Municipal CAOs. The declaration of a State of Local Emergency is at the discretion of Municipal Council.

It is the responsibility of the Regional Emergency Management Coordinator (REMC) for Colchester County to maintain and update this plan on a biennial basis. The Regional Emergency Management Advisory Committee (REMAC) which is composed of the mayor and one other Councillor from each municipality are responsible to review this plan and recommend its approval to Municipal Council biennially.

## 4.0 THEORY OF OPERATION

1. As the complexity of an emergency increases, so will the need for a multi-agency support from across the Colchester region. Colchester County may call upon the Provincial Emergency Management Office (EMO NS) by contacting the On-Duty Officer, to provide or acquire additional resources if necessary. Each agency is responsible for the overall operation of their emergency.

2. Normal Communication and reporting channels will be used to the fullest extend possible.

3. Day-to-day functions that do not contribute directly to the operations may be suspended for the duration of the emergency. Efforts that would normally be required of those functions will be redirected to assisting in completing the objectives set forth in the Incident Action Plan (IAP) either at the site or the Emergency Coordination Centre (ECC).

4. Onsite response will be managed by the onsite Incident Commander. The Regional Emergency Management Coordinator (REMC) will collect information from the Incident Commanders and responding agencies, analyze and disseminate it to all members of the Regional Emergency Management Planning Committee (REMPC) after consultation with the Emergency Coordination Centre Commander (Municipal CAO).

5. Any of the region's municipal CAOs, or designate, have the authority to activate the ECC and when the ECC is activated, its primary function is to coordinate and support operations while continuing essential services to unaffected areas of the Colchester region.

6. Once the immediate response assignments and lifesaving activities have concluded and the emergency response teams have been demobilized, the emphasis shifts from response to recovery operations which is an ECC responsibility.

#### 4.1 Presumptions

The Regional Emergency Management Plan must make some presumptions to be true for the plan's execution.

##### 4.1.1 Incident Presumptions

- a) An incident that affects a Municipality within Colchester County is likely to also affect the surrounding communities and the region.
- b) An emergency incident or disaster may occur at any time of the day or night, weekend, or holiday, with little or no warning.
- c) Some community members who are directly threatened by a hazard may ignore, not hear, or not understand warnings issued by the Colchester Regional Emergency Management Organization (REMO).
- d) The sequence of events in an emergency incident or disaster is unpredictable, therefore, the Plan should be utilized as a guidance document and adapted accordingly for the specific needs of the emergency incident or event.
- e) The fundamental priorities for Colchester REMO during an emergency incident or disaster are:
  - The preservation of life and the protection of people;
  - The protection and restoration of property and infrastructure;
  - Stabilization of the emergency incident or disaster; and
  - Recovery fulfilled to pre-incident conditions.
- f) During an emergency incident or disaster, all operations will be coordinated through the Emergency Coordination Centre (ECC).

- g) The greater the complexity, impact, and geographic scope of an emergency, the more likely a multi-agency response will be required.
- h) Extended incidents that require 24-hour operation will most likely be divided into two operational periods of shifts of 12 hours each. Staffing should be planned accordingly.

#### 4.1.2 Plan Presumptions

- a) The Colchester County Municipal Departments will be familiar with the REMO Plan and their specific responsibilities with the plan.
- b) The Colchester Regional Emergency Management Plan will be reviewed and updated at least biennially by the Regional Emergency Management Coordinator and the Regional Emergency Management Planning Committee. A record of changes will be maintained.
- c) The plan will be exercised at least once annually.

## 4.2 Plan Activation

Accidents that happen on a day-to-day occurrence in the Colchester region are usually handled by the police, fire, ambulances, and local hospitals. These accidents may seem to be major emergencies to those individuals involved, but may not affect the safety, property, and environment of the surrounding community.

Should an incident occur where the size, potential hazard, or seriousness of the emergency appears beyond the capability of the responsibility of the first response agencies, then the senior officer (Incident Commander) may request the activation of the Regional Emergency Management Plan.

The Plan may be activated in full or in part by the Regional Emergency Management Advisory Committee (REMAC) or in part by the Regional Emergency Management Coordinator (REMC) through consultation with the Municipal CAO(s), when required to combat a regional or local emergency or to provide coordinated assistance to mitigate a potential emergency.

There are no firm criteria for the implementation of the Plan, but it could generally be considered when the situation meets one or more the following criteria:

- a) There is a threat of significance to human health, property and/or the environment within the Colchester County region;
- b) Evacuation of all or part of the region is/may be required;
- c) The region has an unusual requirement for volunteer, provincial or federal resources/services for emergency response;
- d) There is need to activate any agreement(s) negotiated by the Regional Emergency Management Advisory Committee;
- e) Additional resources are needed to answer public/media inquiries;
- f) Any Provincial or Federal Emergency Response Plans(s) affecting the region have been activated.

The Incident Commander involved with the emergency shall contact one of the following and inform them of the situation and request the activation of the Regional Emergency Management Plan:

- a) Regional Emergency Management Coordinator
- b) Municipal Chief Administrative Officer(s)
- c) Chair, Regional Emergency Management Advisory Committee
- d) Any member of the Regional Emergency Management Advisory Committee
- e) Region 2 Emergency Management Planning Officer – EMO Nova Scotia

The Regional Emergency Management Coordinator will assess the need to activate the plan by consulting with the Municipal CAOs and members of the Regional Emergency Management Planning Committee. If activation of the Plan is required, the Regional Emergency Management Coordinator will so advise the Chair of the Advisory Committee. The Public Information Officer(s) for Colchester REMO will assist in alerting the following:

- a) Regional Emergency Management Advisory Committee
- b) Regional Emergency Management Planning Committee
- c) Emergency Coordination Centre (ECC) Support Staff

If the magnitude of the emergency or disaster require actions beyond normal procedures, then the Regional Emergency Management Coordinator with consultation with the Municipal CAO(s) may advise the Regional Emergency Management Advisory Committee that a State of Local Emergency (SOLE) be declared in accordance with the authority given to the Committee by the Regional Emergency Management Bylaw.

#### **Declaration Not Required**

The ECC may be activated with or without a Declaration of a State of Local Emergency; however, it is recommended that it be activated in the event a Declaration has been made.

#### **4.2.1 ECC Activation Levels**

The level of ECC activation is determined by the magnitude and scope of the event. Only those ECC functions and positions that are required to meet current response objectives are activated. If staff are not assigned to a function or role, the next available staff position in the ECC organization will assume responsibility for the tasks assigned. If an individual is unsure of which level to activate, the ECC is activated to the higher level since it is easier to scale back staffing than it is to ramp up.

## Activation Phases



Figure 4.2.1 ICS Canada Activation Phases



#### 4.2.1.1 Level 1 – Full Activation (All Personnel)

- Major Incident
- Multiple Sites
- Regional Disaster
- Multiple Agencies Involved
- Extensive Evacuations
- Resources/Support Required
- ECC Set-up
- Regional Emergency Management Advisory Committee Notified
- EMO NS Notified by Regional Emergency Management Coordinator (REMC)

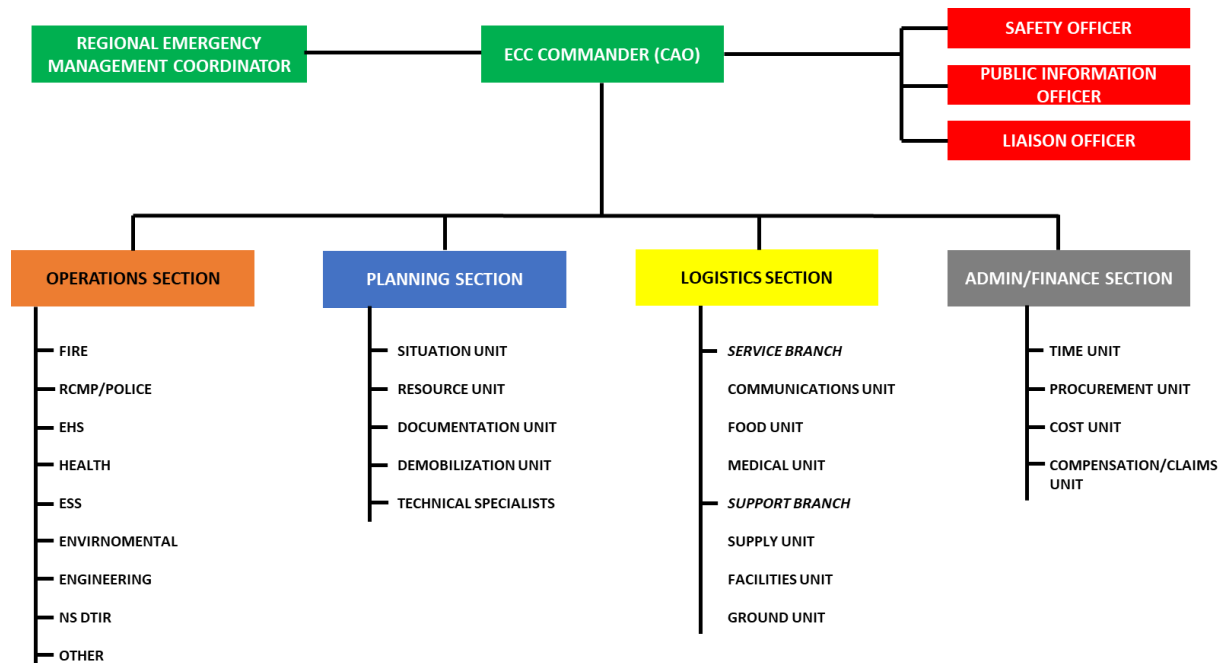

Figure 4.2.1.1 - ECC Level 1 – Full Activation

(The complete implementation of the Incident Command System: Operations, Planning, Logistics and Finance to fully mitigate and recovery from an emergency and/or if a Declaration of a State of Local Emergency.)

#### 4.2.1.2 Level 2 – Partial Activation (Key Personnel and Personnel from Responding Agencies)

- Moderate Incident
- Two or More Sites
- Several Agencies Involved
- Major Scheduled Events (ie. Conference or Sport Event)
- Limited Evacuations
- Some Resources/Support Required
- ECC Set-up
- EMO NS Notified by Regional Emergency Management Coordinator (REMC)

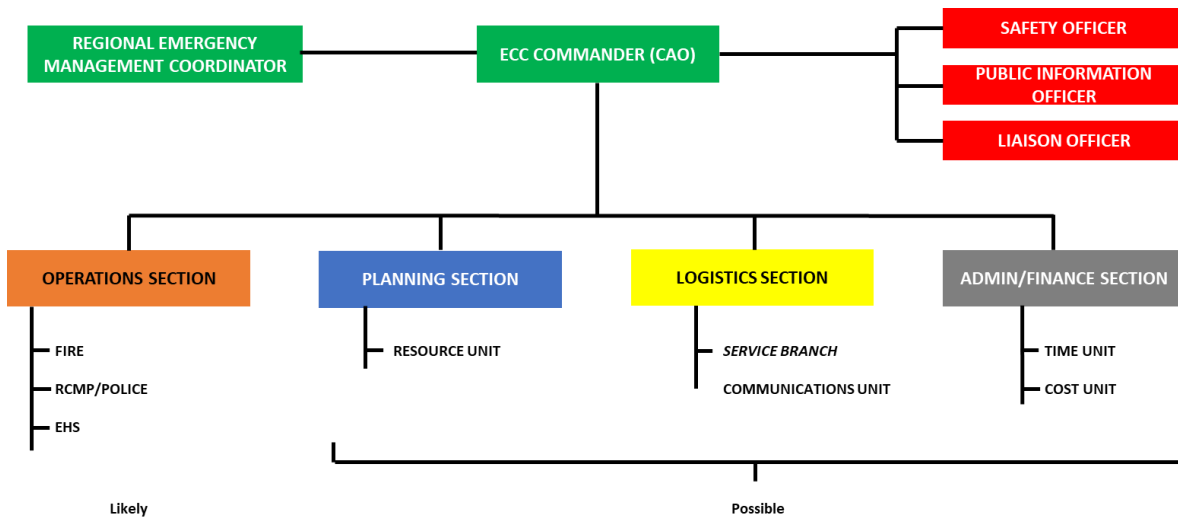

Figure 4.2.1.2 – ECC Level 2 – Partial Activation

(An escalating or worsening incident that requires a State of Local Emergency or is sufficient size to warrant ECC support. Section Chiefs may be called to the ECC to support on-scene Incident Commanders with acquiring and distributing resources, preparing action logs, and support of on-scene operations of emergency responders to suit the size and complexity of the emergency.)

#### 4.2.1.3 Level 3 – Monitoring (Key Personnel Only)

- Small Incident
- One Site
- Several Agencies Involved
- Potential Threat (ie. Flood or Severe Storm Impending)
- Some Agency or Coordination and/or Support Required
- ECC Set-up Optional
- EMO NS Notified by Regional Emergency Management Coordinator (REMC)

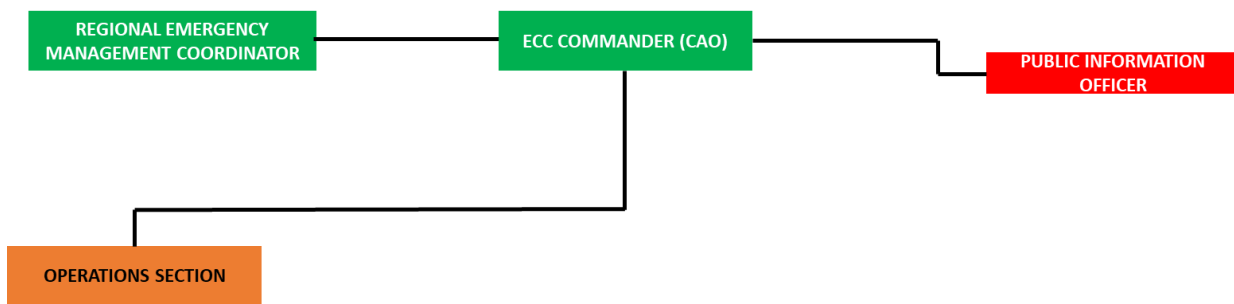

Figure 4.2.1.3 – ECC Level 3 – Monitoring

(Pre-emergency activity to receive and analyze early data for a weather incident to determine the probability of an escalation or worsening of conditions. During a man-made emergency, the Regional Emergency Management Coordinator visits the site to receive information from the Incident Commander on standby to assist.)

#### 4.2.2 Deactivation

The ECC Commander (CAO) is responsible for the ECC deactivation. The Commander considers the requirements of termination from the beginning of the event. Criteria for terminating ECC operations may include:

- Individual ECC functions are no longer required;
- State of Local Emergency is lifted;
- Coordination of response activities and/or resources is no longer required; and
- Incident has been contained and emergency personnel have returned to regular duties.

The Planning Section’s Demobilization Unit Coordinator in the ECC supervisors and coordinates the demobilization process, under the direction of the ECC Commander.

## 5.0 HAZARD IDENTIFICATION AND RISK ANALYSIS (HIRA)

In emergency planning, hazard analysis is the first step in identifying the known and potential impacts a hazard may create. Once the impacts have been assessed, priorities for planning are identified. Effective emergency plans offer mitigation and response solutions to impacts identified during the hazard assessment.

Hazard analysis determines:

- What might occur;
- How often it is likely to occur; and
- How vulnerable the region is to the hazard.

Conducting the HIRA process will identify those hazards that are specific to the Colchester County region and may require a specific action plan (ie. flooding).

Some possible changes within or near Colchester County that could cause hazard analysis information to change over time include:

- New mitigation measured (ie. stronger building codes)
- The opening or closing of facilities or structures that pose potential hazards (ie. hazardous materials facilities or transportation routes)
- Local development activities
- Changes in available resources
- Climatic changes
- Mass gatherings
- Civic threats

There may be other long-term changes to examine as well. These changes, such as climatic changes in average temperatures or rainfall/snowfall amounts, are harder to track but could be very important to the hazard analysis.

After the most recent Hazard Identification and Risk Analysis for Colchester County was conducted by the Regional Emergency Management Planning Committee, the hazards identified as having the greatest potential for disruption in the Colchester region are outlined in Section 5.1.

### 5.1 Regional Hazard Analysis

A Risk and Hazards Matrix is presented in Section 5.2 and the hazards identified as part of the Hazard Identification and Risk Analysis with the greatest potential of disruption are summarized.

#### 5.1.1 Hurricane/Blizzard/Ice Storm

During the winter months, severe weather conditions often occur in this area including heavy snowfalls, ice storms and severe winds. Long-term power outages resulting from these conditions can cause serious hardship. During hurricane season, Nova Scotia often receives the tail end of the storms. Since 2000, the Canadian Hurricane Centre reports about one land-falling hurricane every other year and 1-2 storms of tropical origin moving over land each year.

### **5.1.2 Power Failures**

There are many situations that might result in the loss of power, including an act of terrorism. However, severe winds or a winter ice storm are a more likely cause. Power outages can last from several hours to several days. In colder weather this would cause considerable hardship to the community and significant property damage caused by freezing pipes, spoiled food and damage to interior building materials that need heat during the fall, winter, and early spring to prevent mold and mildew.

### **5.1.3 Wildland Fires**

Wildland fires are a serious concern in themselves as large fires can devastate forested areas in mere days. The Seven Mile Lake fire in Annapolis County in 2016 consumed 369 hectares. Wildland fires that migrate from the forest into communities are referenced as wildland urban interface fires and these types of fires impact the lives of people and structures. In 2008, the Porters Lake fire ordered the evacuation of 5000 people. The fire covered an area of 1925 hectares with a 21-kilometre perimeter. Fortunately, no lives were lost, but two houses were destroyed.

### **5.1.4 Flood**

The region's geographical location is nestled along the eastern most portions of the Minas Basin and on the southern boundary of the Northumberland Strait. Every major watershed that originates in our county's highlands gravitates to one of these two major water bodies. The region has bore witness to some very significant flooding throughout the years, especially over the past half century. Historically, snow melt, river ice pack and heavy rains have been the primary causes of the flooding, but as climate change evolves, it will intensify the frequency and the severity of the storms. Coastal flooding can be complicated by the action of the local tides and storm surges. Hurricanes can often bring heavy rainfall that contribute to localized flooding.

### **5.1.5 Highway Closures**

Two of the busiest 100 Series Highways intersect in Colchester County. Highways 102 and 104 (Trans Canada Highway) are the principal transportation arteries to and from the Halifax Regional Municipality (HRM) and the New Brunswick border or the Newfoundland ferries. These routes often see very high volumes of traffic and if one of these highways is closed due to a storm or an extended emergency, it can divert traffic into the smaller communities along the highways or in some cases trap motorists inside their vehicles on or along side the highways. Major snowfalls have shutdown the Trans Canada Highway along the Cobequid Pass stranding motorists for significant periods of time since its conception with the worst being in 2007 that left hundreds of motorists stranded for over 12 hours.

### **5.1.6 Major Transportation Accidents**

The region's transportation corridors criss-cross every corner of County and roadways see significant traffic volumes. These routes are susceptible to vehicle collisions that could hamper the flow of traffic which could in turn, cause additional accidents or close the roadways. To potentially complicate any transportation accident, masses of materials classified as dangerous by Transport Canada are being moved on the roads through and along our region's most populated areas.

### **5.1.7 Extreme Heat**

Due to changes in the climate, Nova Scotia is experiencing an increase in annual summer temperatures and extreme hot days. Our region is one of areas that as been identified that will see increased episodes of extreme heat events. These events are dangerous for the health and well being of our communities

and can cause illness and even death. It is expected that Nova Scotia will experience an increase in hot days each year and by 2050, regions in Nova Scotia including Colchester County, could see 6-10 days of 30-degree plus temperatures.

#### **5.1.8 Water Shortages/Major Water Main Breaks**

Colchester County is very fortunate that there are significant volumes of ground water that are available to our water utilities and to the public who rely on ground wells. These supplies are impacted by hot weather, lack of rainfall and the lessening amount of snowpack during the winter. In 2020, regions in Nova Scotia had wells go dry and had some water utilities publish usage guidelines or restrictions. If climate change continues at its current rate, it will surely impact the volume of available groundwater. Major water main breaks greatly impact the amount on water reserves or if a break occurs near or at a gravity tank, it can jeopardize fire suppression systems and damage infrastructure.

#### **5.1.9 Epidemic/ Pandemic**

With the weakening effects of antibiotics on bacteria and the ease with which disease can be carried throughout the world by air travel, the potential for an epidemic increase daily. Airborne viruses have been the agents that has caused some of the deadliest outbreaks in our region. In 1918, the Spanish Flu took the life of over 2000 Nova Scotians over a three-year span. The H1N1 Influenza was identified in April 2009, and this new virus quickly spread throughout the world and the World Health Organization (WHO) declared H1N1 a pandemic in June of 2009. This virus claimed the lives of 7 people in Nova Scotia from April 2009 to January 2010. In 2020, the Coronavirus (COVID-19) quickly spread throughout the world and the has become one of the deadliest pandemics since the Spanish Flu. Nova Scotia has had 79 deaths over the span of March 2020 to May 2021 and that number could increase before a complete vaccination of the public is finalized.

#### **5.1.10 Communication Failures**

As the world migrates deeper into technology, the reliance on mobile phones and stable internet is becoming more and more apparent. Over the past few years, Nova Scotians have had some major communication breakdowns and lapses. In August of 2017, all communication and internet east of Montreal was interrupted by a cascading failure due to a fibre optic cables that were severed in Quebec and New Brunswick. When Hurricane Dorian made landfall in August of 2019, it damaged several cellular towers and the extended loss of power shut down others. The latest major lapse was in July of 2020, when 911 services in the Maritimes was interrupted for nearly two hours due to a switch failure. Consumer services are not the only services impacted when fibre cables are damaged. The provincial trunk mobile radio (TMR) towers are linked by fibre optic and when a significant outage impacts more than a few towers, it impacts emergency service providers as well as provincial agencies.

## 5.2 Risk Analysis Matrix

		Severity					
		What is the Severity of Injuries/Potential Dangers/Financial Impacts					
		1 – Insignificant	2 – Minor	3 – Moderate	4 – Significant	5 - Catastrophic	
Likelihood How likely is the event to occur		5			Highway Closure Major Vehicle Accident	Blizzard Hurricane River Flooding	
		Highly Probable: Every 5 years or less		Major Frost/Freeze	Extreme Heat Major Water Main Break	Chemical Spill/Release Coastal Flooding Epidemic Extended Power Outage Flash Flood Ice Storm Major Fuel Spill Water Shortages Wildland Fire Communication Failure	
4	Likely to Occur: Once every 10 years						
3	Might Occur: Once every 20-30 years		Civic Disobedience Hostage Event	Agricultural Dyke Break Drought Washout Infrastructure	Fuel Shortage Industrial Explosion Major Hailstorm Major Urban Fire Pandemic Plane Crash Train Derailment Water Pollution	Mass Shootings	
2	Not Expected: Could occur every 50 years			Landslide Poor Air Quality Sink Hole Structural Collapse Waste Disposal Problem	Food Shortage Natural Gas Pipeline Explosion Radiological Event	Dam Break	
1	Rare: Once every 100+ years			Tornado	Earthquake Terrorist Attack	Tsunami Solar Flare	



## Risk Analysis Matrix – Definitions of Risk Ratings



Very High (VH) Risk – These risks are classed as primary or critical risks requiring immediate attention. They may have a high or probable likelihood of occurrence and their potential consequences are such that they must be treated as a high priority. This may mean that strategies should be developed to reduce or eliminate the risk and mitigation in the form of (multiagency) planning, exercising, and training for these hazards should be put in place and monitored on a regular basis. Consideration should be given to specific planning to the risk rather than generic.



High (H) Risk – These risks are classed as significant. They may have high or low likelihood of occurrence, however, their potential consequences are sufficiently serious to warrant appropriate consideration, after those risks classed as ‘very high’ are addressed. Consideration should be given to the development of strategies to reduce or eliminate the risks, and that mitigation in the form of (multi-agency) generic planning, exercising, and training should be put in place and monitored on a regular basis.



Medium (M) Risk – These risks are less significant, however may cause upset and inconvenience in the short-term. These risks should be monitored to ensure that they are being appropriately managed, and consideration given to their management under generic emergency planning arrangements.



Low (L) Risk – These risks are both unlikely to occur and not significant in their impact. They should be managed using normal or generic planning arrangements and require minimal monitoring and control unless subsequent risk assessments show a substantial change, prompting a move to another risk category.

## 5.3 Hazard and Risk Mitigation

### 5.3.1 Blizzards

Living in Atlantic Canada means winter storms and occasional blizzards. We expect them and for the most part consider them to be a nuisance, with expected short-term road closures and power interruptions. In the context of this plan, only those events that are more intense and deliver large amounts of snow are of concern. The best example is the blizzard of 2003 that was dubbed as “White Juan” which dumped 95 cm of snow within 24 hours to some regions of the province. That storm and others like it anticipated in the future are the interest of this plan. Environment Canada defines a blizzard as follows:

Table 1. Environment Canada Alerting Parameters for a Blizzard Warning

Alert Type	Location	Threshold Criteria
Warning	National, except North of the 20'	When winds of 40 km/hr or greater are expected to cause widespread reductions in visibility to 400m or less, due to blowing snow or blowing snow in combination with falling snow for at least 4 hours.

Table 2. Environment Canada Alerting Parameters for a Snowfall Warning

Alert Type	Location	Threshold Criteria
Warning	Newfoundland and Labrador, New Brunswick, <b>Nova Scotia</b> , Prince Edward Island, Magdalene Islands, Quebec	When 15 cm or more of snow falls within 12 hours or less.

### 5.3.2 Hurricanes

Hurricanes were, until recently, rare in Nova Scotia. As they approach the province, they were usually downgraded to a tropical or post tropical storm with reduced winds and rains. Historically, they would track up the eastern seaboard of the United States, but typically lose their energy over colder northern waters. However, that is changing with the Canadian Hurricane Centre expecting more hurricanes to reach Nova Scotia with more regularity as our coastal waters continue to warm.

Table 3. Canadian Hurricane Centre Tropical Storm Alerting Parameters

Alert Type	Threshold Criteria
Tropical Storm Watch	Public announcement for a specific geographic area that tropical storm conditions are a possible threat within 36 hours. This includes sustained winds between 63-118 km/h.
Tropical Storm Warning	Public announcement that tropical storm conditions are expected in a specific geographic area within 24 hours. This includes sustained winds between 63-118 km/h. <i>Note: As tropical storms are usually accompanied by heavy rainfall, local flooding can also be expected.</i>

Table 4. Canadian Hurricane Centre Hurricane Alerting Parameters

Alert Type	Threshold Criteria
Hurricane Watch	Public announcement for a specific geographic area that hurricane conditions are a possible threat within 36 hours. These conditions include average sustained winds of at least 119 km/h, dangerously high-water levels, or a combination of high water and waves
Hurricane Warning	Public announcement that one or both of the following dangerous effects of a hurricane are expected in a specific geographic area in 24 hours or less: (1) average sustained winds of at least 119 km/h; (2) dangerously high-water levels, or a combination of dangerously high water levels and exceptionally high waves. <i>This can happen even if expected winds are less than hurricane force. A hurricane also brings the threat of local flooding from heavy rainfall.</i>

### 5.3.3 Floods

During the early spring, it is common for our region to experience heavy rainfalls that accompany temperatures well above freezing and in those instances melting snow adds to the water volume carried by the river watersheds. The increased flow of water that descends in the river course can often be

impeded by ice pack at the bottom of the watershed. The most significant impacts have been associated along the Salmon and North Rivers as both converge onto the marsh bodies that lay north of the Town of Truro. Colchester County has seen some dramatic flooding over the past half century and most recently in 2003 (Truro area), 2012 (Truro area) and 2014 (Great Village & Lower Debert).

The region is also susceptible to coastal flooding primarily from sea rise associated with climate change, significant rain fall that coincides with astronomical higher tides with strong offshore winds.

The Municipalities in Colchester County have worked independently and jointly on flood mitigation projects and development strategies that have created resilience along the coast and waterways that flow along side our populated areas.

## 5.4 Business Impact Analysis

The ability to recover from an event is subject to the amount of damage to infrastructure and the resources available to repair the damage and resume normal operations. Critical infrastructure components that will impact a recovery and return to business as usual are discussed in this section.

### 5.4.1 Preparedness Level

The Colchester County Regional Emergency Management Organization (Colchester REMO) maintains a part time Regional Emergency Management Coordinator (REMC) by Agreement. The REMC is assisted by an Alternate Regional Emergency Management Coordinator.

### 5.4.2 Severe Weather Notifications and Alerting

The CAOs for the Towns' and County, and the Regional Emergency Management Coordinator for the Colchester REMO receive weather statements, watches and warnings from EMO Nova Scotia as prepared by Environment and Climate Change Canada. Severe weather advisories and statements are issued 5 days before the anticipated event with Watches and Warnings posted 48 hours before a significant weather event is expected to impact the region. The REMC responds by sending out severe weather bulletins describing expected severe weather forecasts to the CAOs for the Municipality of Colchester and the Town's of Truro and Stewiacke, all Public Works Directors, local RCMP Commander and municipal Police Chief, local Fire Chiefs and Colchester Ground Search and Rescue.

Depending on the forecasted severity, the Colchester Regional EMO (REMO) will maintain a storm watch seeing the Colchester Regional EMC in contact with EMO Nova Scotia by teleconferences for critical updates. Critical weather forecasts and updates are sent to each CAO for the Municipality of Colchester and the Town's of Truro and Stewiacke, all Public Works Directors, local RCMP Commander and municipal Police Chief, local Fire Chiefs and Colchester Ground Search and Rescue.

Early storm preparation starts with situational awareness, followed by more intentional active monitoring usually conducted by the REMC. As the weather appears to become threatening, the Emergency Coordination Centre (ECC) is prepared to staff according to a Level 1 through 3 mobilization of the ECC. Members of the Planning Committee are requested to attend the ECC according to the need for filling key positions critical to maintaining a functional staffing level to ICS Canada standards for those times when the size and complexity surpass the capability of the REMC to resolve the issues.

Colchester REMO sends notices via local media outlets, mass notification software (Alert TC), and municipal social media pending severe weather.

Any citizens can and should seek assistance through the 911 system requesting police, ambulance, or fire as their needs dictate. Attendance by one agency will result in mutual aid requests, and attendance by other agencies such as NS Power, telecommunication companies, municipal Public Works and the NS Department of Transportation and Infrastructure Renewal (NSTIR).

#### **5.4.3 Communications – Radio, Telephone, Satellite Phone and Mass Notification Software**

All emergency responders are connected by either one or both Very High Frequency (VHF) and Trunk Mobile Radios (TMR), cell phones, and land lines for voice or text messaging. The dispatch of emergency services can originate from EHS Dispatch for ambulances out of Bedford, RCMP officers from RCMP Telecom in Halifax, Valley Communications in Kentville for the Municipality of Colchester's Fire Service, and the Truro Police Service dispatches the Town of Truro's Police and Fire Services. Police Services and EHS paramedics principally utilize the TMR communications platform while fire services in the Colchester region employ VHF and TMR communications.

Currently, there are three satellite phones in the Colchester region with one being assigned to the ECC. The two other phones are attached to the local ground search and rescue team and if required additional resources may be requested from the provincial Public Safety and Field Communications group.

The region's fire services presently are utilizing a mass notification software called "I am Responding" (IaR) that can mass notify all the firefighters either through their individual agencies or by each service's respective dispatch centres.

A failure of any one or all of radio, telephone, and mobile phone services could see the staffing of the ECC by amateur radio operators through their facilities within the ECC.

#### **5.4.4 Communications – Truro Amateur Radio Club (TARC)**

Colchester Region's dedicated volunteer Amateur Radio Club can provide communications as a fall back or failsafe position. This club has a fully functioning radio room in the current primary Emergency Coordination Center. Each member regularly practices remote and offsite amateur radio broadcasts annually at operation Field Day. This gives the Colchester Region a communications link in addition to other means and when other systems fail.

#### **5.4.5 Capacity to Respond to Casualties and Damage**

Within the Colchester Region, there are 2 paramedic bases with 12 on duty paramedics, 18 fire stations with 563 active volunteer and 18 career firefighters, 5 police detachments with 80 constables and supervisors, and Colchester Ground Search and Rescue with 30 members, the Canadian Red Cross, Salvation Army, and the Department of Community Services. Each has the capacity to mobilize once requested. Each emergency response group has or is in process of taking ICS courses to form a unified command with one incident commander for command and control at the scene of an emergency.

Damaged property and buildings become the responsibility of the Owner following the attendance by emergency services, public works, and private contractors to clear building debris for the purposes of restoring roadways, stabilize access to properties for access by owners and their insurers to begin the process of more permanent relocation, demolition, and reconstruction which is the responsibility of property and building owners.

The Municipality along with the Province would establish claim centers where civilians can go to file insurance claims and seek provincial financial assistance. This practice was effectively coordinated during the 2003 floods that greatly impacted the central core of the region.

In addition, civilian volunteers and other community groups like the Samaritan Purse will want to assist in the recovery after a disaster. If these volunteers are to be utilized, they can be mustered to a designated location, registered, and tasked out with identified personnel to assist with clean-up of property and buildings with instructions in clean-up dos and don'ts.

#### 5.4.6 Water Distribution

All the population relies on their water supply from either Municipal utility with a municipal distribution system, or private homes on private wells. With combined population of 50,585 people, approximately 20,000 are on a municipally owned and operated water system in predominately urban and suburban areas of the Colchester Region that includes:

- Town of Truro
- Town of Stewiacke
- Village of Tatamagouche
- Village of Bible Hill (areas along and adjacent to Pictou, College and Vimy Roads)
- Debert (Industrial Park, old CFS Base and small portion of Plains Road)
- Lower Truro (along Robie Street)
- Salmon River (along Fir Avenue)

All these water utilities are managed by either a Town or the Municipality of Colchester, each responsible for the operation and delivery of potable drinking water. Professional staff skilled in specific trades operate the system and are available 24/7 to maintain and repair the system as needed. They are on call and available for emergency operations.

In the event of a power outage, full time municipal staff from municipal units are on call to monitor operation and repair problems to ensure continuous operation. When required, generators maintain pumping capacity to the reservoirs for distribution by gravity in the event of a power outage.

In the less densely populated rural and remote areas, the primary source of potable water for domestic use is by private onsite wells owned, maintained, and tested by the homeowner. These account for the remaining population, approximately 30,585 people.

On average, homeowners on private wells who lose power are without water for drinking, cooking, cleaning, flushing toilets, bathing, laundry; those simple things we are accustomed to having. This

population becomes totally dependent on bottled water for consumption. To assist with their needs, public service announcements that filling a bathtub before the loss of power is important for toilet flushing and laundry cleaning. Water becomes a priority seeing the supply of bottled water for drinking and cooking increasingly purchased in advance of a severe weather event. These supplies are usually highly sought at local markets and stores before the storm arrives. Bottled water distribution for human consumption will become a critical factor for life safety in the event of an outage for more than 3 days as supplies begin to dwindle due to consumption. The rule of 2 liters per person per day is the benchmark; that includes the same amount for a dog, less for a cat.

#### **5.4.7 Water Distribution and Consumption – Livestock**

Individual farms along with farm animal rescue groups are responsible for farm and domestic animals. Colchester REMO may make contact for assistance, but generally the rescue and care of farm animals is not the responsibility of Colchester REMO. Owners and rescue groups will be required to manage their livestock water needs. Supply is managed by water hauling companies established to haul bulk raw water by tanker. To give a sense of the amount of water needed, the following applies.

Dairy Cows, non-lactating 40 liters per day  
Dairy Cows, lactating 115 liters per day.  
Horses 32 to 49 liters per day (depending on the size)  
Swine 9 liters per day  
Sheep, lactating 10 liters per day  
Chickens 280 to 450 liters per 1000 birds

Source: Ontario Agriculture, Food and Rural Affairs  
Water Requirements of Livestock Factsheet, May 2007

#### **5.4.8 Sewage Collection and Treatment**

There are 6 separate sanitary sewer systems in the Colchester region. The Municipality of Colchester own, operate, and maintain sanitary collection systems that flow into 5 separate sewage treatments located in Tatamagouche, Debert, Great Village, Brookfield, and the Central Colchester Wastewater Treatment Facility in Lower Truro. The other sewage treatment facility is situated the Town of Stewiacke. Each of these facilities is operated by municipal staff who are available 24/7 to repair and operate any parts of the systems. Each of the sewage treatment facilities has built in emergency generators to maintain operations. Of the 45 pumping stations throughout the region, a small number of the larger lift stations have built-in generators to maintain flow to the sewerage treatment facilities. The remaining lift stations are serviced according to emergency plans that could see municipal crews transporting portable generators from station to station to ensure their contents reach the treatment facilities.

#### **5.4.9 Public Works Staff**

Municipal units have full time professionally skilled staff that preform their public works capabilities. Staff maintains the continuous operation of roads, storm sewers, flood control measures, snow removal, and general repairs to critical infrastructure. Each has its own yard for materials and equipment storage as well as each has significant inventories of heavy and light equipment with qualified operators. Each municipal unit has standing agreements with private contractors to supply additionally equipment or



resources. Public Works and the Nova Scotia Department of Transportation and Active Transit (NSTAT) staff are the first line of defense to keep roads open and infrastructure operating for distribution of aid, emergency workers, and emergency management officials during a crisis.

#### **5.4.10 Nova Scotia Department of Transportation and Active Transit (NSTAT)**

They are responsible for maintenance of existing roadway infrastructure. There are seven yards operated out of Bible Hill, Brookfield, Londonderry, Economy, Upper Stewiacke, Earltown and Tatamagouche that maintain a fleet of plows and heavy equipment suited for large road work projects with capacity to rebuild and repair damage to their infrastructure.

#### **5.4.11 Nova Scotia Power (NSP)**

Nova Scotia Power is responsible for electrical infrastructure in Colchester County. In the event of a storm, they monitor forecasts looking for the type of weather than typically causes power outages. They maintain crews across the province for repairs, post online power outage locations on their website (<http://outagemap.nspower.ca/external/default.html>) and provide estimates of the time to repair to full restoration.

They have their own Emergency Coordination Center which they staff during all outages to assess the damage, direct repair crews, and establish contact with critical customers to ensure restoration times.

#### **5.4.12 Other Critical Infrastructure**

While Colchester REMO is not responsible for the distribution of these essential products, the following information should be helpful.

##### **5.4.12.1 Furnace Oil Heating Fuel Distribution**

With a cold weather heating season, the Imperial Oil terminal in Dartmouth has storage tanks to maintain a strategic reserve of home heating oil. Wilson's Fuel/Superline and Blue Wave Energy are both located in the Truro Industrial Park and do maintain onsite supplies of furnace oil. Distribution by these local suppliers is based upon delivery to regular customers, many of which are Emergency Service providers.

##### **5.4.12.2 Gasoline and Diesel Fuel Distribution**

There are no strategic reserves. Those that rely on gasoline are vulnerable to loss of these products within several days of the last delivery by ship from the Gulf of Mexico and European refineries. There are no refineries in Nova Scotia, only the Dartmouth terminals for Imperial Oil and Irving Oil which receives ships containing market ready fuel products that are immediately distributed to gas station retailers. As a result, supplies are vulnerable when ships are not able to deliver fuels to the Dartmouth terminal.

With no strategic reserve of gasoline, it is entirely probable that many gas retailers will be drained of all gasoline within two to three days without product for a significant period if anything shuts down the US or European refineries or prevents marine shipments from maintaining their on-time delivery schedule to Nova Scotia.

Nova Scotia is only partially dependent on the Irving Refinery in St. John, New Brunswick. Assuming it has supplies on hand and production can meet the demand it could be a source during an emergency as Irving currently ships product across the Bay of Fundy to the Dartmouth terminal. The problem for the refinery is all raw oil is shipped by marine tankers to St. John. They are also vulnerable to supply chain shortages of raw oil if a severe weather prevents ships from docking or leaving the refinery.

## 6.0 EVACUATION

*Reference: Colchester Region Emergency Management Evacuation Plan*

The evacuation function describes how the public would be evacuated out of areas affected by an emergency that are deemed to be too hazardous for people to stay in place. Evacuation methods will be dependent on the incident and is the responsibility of the Incident Commander on site. A key component of the evacuation process is to look after the evacuees once they are evacuated and this is the responsibility of the REMO. This function shall be performed by the REMC unless the ECC is activated, at which time it will be organized and managed by the Logistics section Chief within the ECC.

During an emergency, the ECC operational support functions may include:

- Damage Assessment
- Debris Management
- Livestock and Pet Coordination

### 6.1 Evacuee Alerting and Sheltering

The decision to evacuate any specific area has two levels:

**Immediate Evacuation:** An immediate and sudden leak, spill, or fire at a fixed facility or mobile transport vehicle that requires identification of impacted areas to be evacuated followed by an immediate evacuation. This is the responsibility of the Incident Commander (IC) with support from the REMC to coordinate the moving of people and the opening of shelters to receive and house evacuees.

**Alerting:** Evacuees shall be notified to evacuate within the areas identified by the IC. Alerting shall be a door-to-door campaign by police with assistance from other agencies as required and available.

**Time Critical Evacuation:** An event that unfolds over several days, such as hurricanes that require an evacuation. In these cases, the evacuation will be managed by the ECC prior to the arrival of the severe weather event. The ECC will provide notifications and alerting, transport, and sheltering.

**Alerting:** Evacuees shall be notified to evacuate within the areas identified by the ECC Commander. Alerting shall be a police door to door campaign notifying citizens to evacuate as well as providing each family so advised of the location of their nearest shelter either within Colchester County or neighbouring Counties. Police may accept assistance from other agencies as required and available. Additional alerting shall be through local media (radio), social media and mass notification software. Evacuations will be supported by the ECC opening shelters to house displaced people and provide them with the necessities of life.

## 6.2 Evacuation Process

Evacuation takes place within a process that begins with preparing for the possible need to evacuate populations at high risk from imminent or actual disaster. It involves ongoing risk monitoring and management as the situation and needs of evacuees evolve over time, and only ends with their safe, voluntary, and sustainable reintegration back home or in alternate locations.

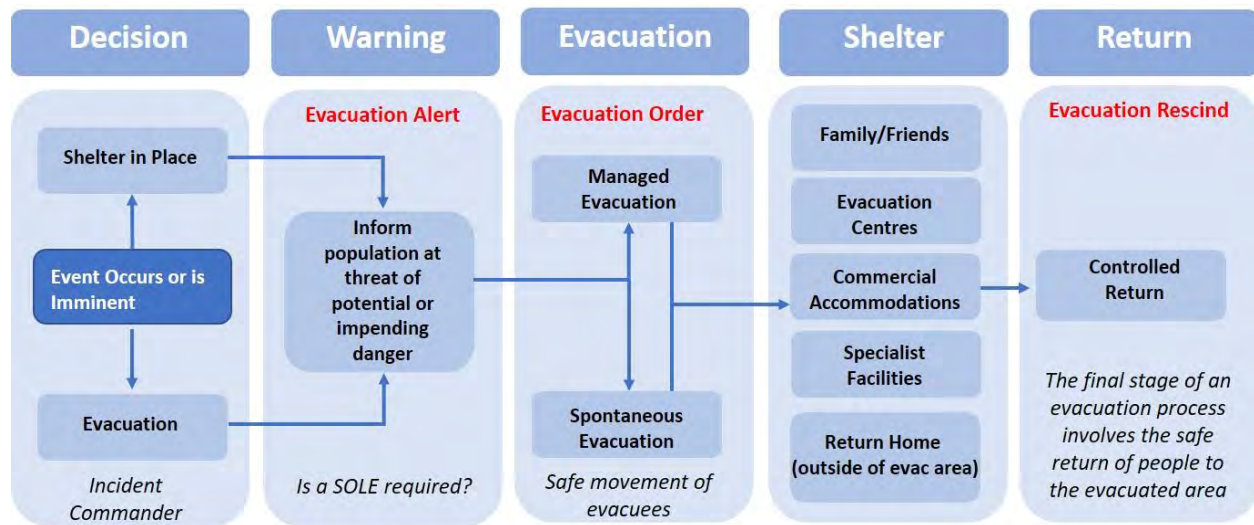

Figure 6.2 – Evacuation Process

## 7.0 REGIONAL EMERGENCY MANAGEMENT ORGANIZATION (REMO)

In March of 2000, the municipalities of the Town of Truro, Town of Stewiacke and the Municipality of Colchester agreed to enter into an agreement to provide for a coordinated response to an emergency with the region of Colchester County. The Colchester Regional Emergency Management Organization consists of the Regional Emergency Management Advisory Committee (REMAC), the Regional Emergency Management Coordinator (REMC) and the Regional Emergency Management Planning Committee (REMPC).

### 7.1 Regional Emergency Management Advisory Committee (REMAC)

The REMAC consists of:

- Mayor from each Colchester County Municipality (Town of Truro, Town of Stewiacke and the Municipality of Colchester);
- One representative Councillor from each Colchester County Municipality;
- Chief Administrative Officer from each Colchester County Municipality; and
- Regional Emergency Management Coordinator (REMC).

The Regional Emergency Management Advisory Committee shall, on behalf of the Regional Emergency Management Organization:

- Be responsible for the preparation and approval of Regional Emergency Management Plans;

- b) Provide direction to the Regional Emergency Management Coordinator and the Regional Emergency Management Planning Committee, as deemed appropriate by the Regional Emergency Management Advisory Committee from time to time;
- c) Brief Council on the development and approval of Regional Emergency Management Plans whenever required to do so by Council; and
- d) Brief Council on developments during a State of Local Emergency whenever required to do so by Council.

## 7.2 Regional Emergency Management Planning Committee (REMPC)

The REMPC shall on behalf of the Regional Emergency Management Organization:

- a) Be responsible for recommending policy and procedures to the REMAC for maintaining a reasonable state of preparedness for emergencies;
- b) Assist the Regional Emergency Management Coordinator (EMC) in the preparation and coordination of the Regional Emergency Management Plans;
- c) Advise the REMAC on the preparation and approval of the Regional Emergency Management Plans, whenever required to do so by the REMAC.
- d) Upon request, assist the REMAC in the briefing of Councils on the development of Regional Emergency Management Plans;
- e) Perform such other duties as may be required by the REMAC or by the Agreement.

The Planning Committee should include, but not be limited to, the following members:

- a) Regional Emergency Management Coordinator (REMC) - Chair;
- b) Community Services
- c) Health Services
- d) Emergency Social Services
- e) Police/RCMP Services
- f) Fire Services
- g) Communication Services
- h) Transportation Services
- i) Engineering Services
- j) Public Information Services
- k) Utility Services
- l) Financial Services
- m) Legal Services

## 8.0 RESOURCE REQUIREMENTS AND LOGISTICAL SUPPORT

### 8.1 States of Emergency

The Emergency Management Act allows for 2 separate types of states of emergency.

The first is a State of Local Emergency (SOLE). The municipal government enacts it either through a resolution of council or by the direct request of the municipal mayor or warden. It is valid for 7 days and can be renewed. The State of Local Emergency can also be issued by the Minister of Emergency Management.

The second is a State of Emergency. The minister responsible for emergency management for the province declares it. It is valid for 14 days and can be renewed.

States of emergency can be declared for a specific geographical portion of the province or province wide.

A State of Local Emergency may be called to:

- Confiscate property;
- Control/Prohibit travel;
- Order evacuations;
- Enter without warrant; or
- Command assistance.

#### 8.1.1 Declaration of a State of Local Emergency

Declaration of a State of Local Emergency can be declared by a Council of a Municipality (Form 4), a Mayor/Warden (Form 5) or by the minister responsible for emergency management.

The Declaration of a State of Local Emergency forms and decision flowchart can be found in the Annex section of the Emergency Management Plan.

#### 8.1.2 Renewal of a State of Local Emergency

If the State of Local Emergency is still required beyond 7 days, the Council of a Municipality or Mayor/Warden will need to complete the renewal request (Form 6). To renew a State of Local Emergency, the following is required:

- Date the declaration form was signed;
- Date and time the extension will start and finish;
- The Mayor/Warden or designate available to sign the form.

The Renewal of a State of Local Emergency form can be found in the Annex section of the Plan.

#### 8.1.3 Termination of a State of Local Emergency

The termination of the State of Local Emergency needs to be concluded by the Council of a Municipality. To terminate the state of local emergency (Form 7), the following will need to be secured:

- Date the declaration form was signed;

- Date the renewal form was signed if applicable;
- Date and time in which the state of local emergency will end;
- The Mayor/Warden or designate available to sign the form.

The Termination of a State of Local Emergency form can be found in the Annex section of the Plan.

## 8.2 Communications

### 8.2.1 Emergency Communications Plan

Once the Emergency Management Plan is implemented, it will be important to ensure that communications are established between the emergency site and the Colchester Regional Emergency Coordination Centre (ECC). At all times open lines of communication are to be established with internal and external organizations. The type and severity of the crisis will determine which stakeholders are involved.

The ECC will be equipped with land line telephones, portable hand radios (VHF and TMR), and a satellite phone with the necessary channels to communicate with police, fire, EHS and the Nova Scotia Emergency Management Office (NS EMO). To compliment the voice communication options, the ECC is supported by two internet providers to ensure redundancy.

Communications between the ECC and the other responding agencies can be supported using a runner if radio communications become overwhelmed. The Communication Unit Leader (Logistics) is responsible for liaising with and coordinating additional emergency communications efforts. A record of all communications is to be recorded on the applicable ICS Form at the ECC.

### 8.2.2 Emergency Public Information Plan

Emergency situations can quickly become the centre of local, national, and international attention, and often receive significant media attention. It is important that Colchester Regional EMO speak with one voice during an emergency that impacts the entire region.

Upon implementation of this Emergency Management Plan, it will be important to coordinate the release of accurate information to the news media, issue authoritative instructions to the public, and respond to or redirect individual requests, for, or reports on, information concerning any aspect of the emergency.

To fulfill these functions during an emergency, the following position will be established within the Emergency Coordination Centre:

- Public Information Officer (PIO) (ICS Command Staff position)

The Public Information Officer reports to the ECC Commander (ECCC) and is responsible for:

- Establishing a communications link with the Community Spokesperson, and any other media coordinator (i.e., provincial, federal, private industry, etc.) involved in the incident, ensuring that all information released to the media and public is timely, full, and accurate.
- Ensuring liaison with the ECCC to obtain up to date information for media releases, coordinate individual interviews and organize press conferences as required.

- Ensuring any media releases are approved by the ECCC prior to distribution.
- Monitoring new coverage and correcting inaccurate information.
- Maintaining copies of media releases and newspaper articles pertaining to the emergency.

The Emergency Public Information Plan can be found in the Annex section of the Plan.

### Information Mediums

The Public Information Officer (PIO) will consider contacting the following media sources to coordinate timely information being communicated to the public.

- |                     |                |  |
|---------------------|----------------|--|
| • CBC News          | 1-902-420-4100 | <a href="mailto:cbcns@cbc.ca">cbcns@cbc.ca</a>                                 |
| • CTV Atlantic      | 1-920-454-3200 | <a href="mailto:atlanticnews@bellmedia.ca">atlanticnews@bellmedia.ca</a>       |
| • Global Halifax    | 1-800-833-0592 | <a href="mailto:halifax@globalnews.ca">halifax@globalnews.ca</a>               |
| • Bounce 100.9      | 902-893-6397   | <a href="mailto:truronewsroom@bellmedia.ca">truronewsroom@bellmedia.ca</a>     |
| • Pure Country 99.5 | 902-893-6397   | <a href="mailto:truronewsroom@bellmedia.ca">truronewsroom@bellmedia.ca</a>     |
| • The Breeze 94.1   | 1-902-755-1320 | <a href="mailto:newglasgownews@stingray.com">newglasgownews@stingray.com</a>   |
| • Q97.9             | 1-902-755-1320 | <a href="mailto:newglasgownews@stringray.com">newglasgownews@stringray.com</a> |
| • Hot105.5          | 1-902-566-6397 | <a href="mailto:news@ocean100.com">news@ocean100.com</a>                       |
| • 100.3 Ocean       | 1-902-566-6397 | <a href="mailto:news@ocean100.com">news@ocean100.com</a>                       |

The PIO will also craft messaging to publish across a mass notification software (Alert TC) that is being utilized within the region. The software can notify residents via an app, text message, email and/or phone message. That same messaging can be coordinated across the region’s Municipal social media platforms.

### 8.3 Emergency Coordination Centre (ECC)

Should the requirement arise to activate the Colchester REMO Emergency Coordination Centre (ECC), the location of the ECC is as follows:

- |  |  |
|--|--|
| The Primary ECC location is                    | 37 Pictou Road<br>Bible Hill, NS                                     |
| Alternate ECC locations<br>for Colchester REMO | Town of Truro Police Station<br>776 Prince Street<br>Truro, NS       |
|  | Colchester East Hants Health Centre<br>600 Abenaki Road<br>Truro, NS |

The Incident Command System (ICS) assists the ECC Commander in determining the best staffing levels for the incident. Every incident has certain major management activities or actions that must be performed. Even if the incident is very small, and only one or two people are involved, these activities will



still always apply to some degree. The following five primary management functions are the foundation upon which the ECC's organizational structure is based:

- Command
- Planning
- Logistics
- Operations
- Finance/Administration

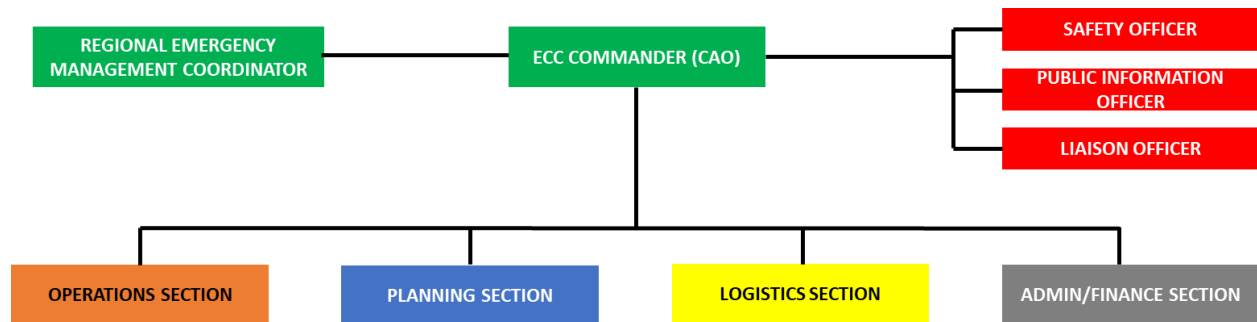

Understanding that the ECC is based on the Incident Command System and that it is a modular organization and uses a manageable span of control, the ECC Commander can activate as many positions as they require.

The term “Go Big Early” describes the initial activation of the emergency response organization to a level that may be more than you eventually need. Get everyone in the ECC and if you do not require certain staff after the first few hours, release them. This is done for two reasons: to provide the work force that will enable the ECC Commander to ‘get ahead’ of the situation, and secondly, as new information comes into focus, the staff may be required, and they are already there and ready to act.

### 8.3.1 ECC Principal Tasks

The ECC has five primary tasks that it will be the focus during an emergency once it is activated.

- **Provide support to the Incident Command Post(s).** The ECC receives instructions from the Incident Command Post (ICP) concerning what support is required (such as equipment, information, media relations, coordination with external agencies) and how to provide it (such as access/exit routes, schedules, etc.) The ECC obtains the necessary support and coordinates its provision to the ICP's staging area. These resources may originate from:
  - Municipal resources;
  - The community level;
  - Mutual aid sources; or
  - Provincial or Federal government resources.

- **Manage the emergency response for Colchester County.** Some emergency response operations may be required across the entire municipality to mitigate threats from an emergency. For example, reception and/or evacuation centres may be needed, or public safety instructions provided for persons outside the incident site. Traffic flow control may be required to and from the incident site.
- **Provide information to the public on the emergency and the region’s response.** The public needs timely information so it can protect itself, and, in some cases, play a part in emergency operations, and to minimize fear and anxiety. For these reasons, the Emergency Coordination Centre prepares and disseminates information.
- **Coordinate with County and municipal services.** In general, the Emergency Coordination Centre needs to coordinate its activities with municipal services and other organizations affected by the emergency. It does so by establishing links to the following locations:
  - Municipal offices;
  - Service dispatch centres (police, fire, public works etc.);
  - Emergency operation centres (those at hospitals, centres of education, post secondary institutions, provincial agencies); and
  - Emergency facilities locations (registration centres, comfort centres, shelters).
- **Ensure continued operations in unaffected areas of the County.** The ECC must ensure that there is no interruption in the provision of emergency services (such as fire protection) and essential services (ie. hospital, water, sewer, electricity, waste management, telephone, etc.) in unaffected areas outside the incident site. In cases where the municipality is not responsible for these services, the ECC works with the appropriate alternative organization(s).

#### 8.4 Volunteers

In our region, the residents have always had a strong desire to volunteer in their communities. Regardless of where people choose to donate their time, in a crisis, these individuals will “just appear” offering to help. The willingness of people who volunteer when needed has been well documented during disasters. During the Calgary floods in 2013, droves of people offered to help with the expansive cleanup. Locally, in 2003 when the region’s central area experienced one of its worst floods, individuals and community groups were quick to volunteer.

Emergency Management Officials are aware of the benefits that volunteers can bring and have adopted the concept that the Colchester Regional EMO should be prepared to accept assistance by the public as a matter of formal agreement, making volunteers an important part of the Emergency Plan.

Finding volunteers are be accomplished in a variety of ways:

- A staff person can be appointed as a Volunteer Coordinator by the CAO to garner interested community members on a central registry for future contact; or
- The Logistics Section Chief, through the ECC Commander and their Information Officer, place a media wide call for volunteers to help describing the assistance needed and the locations. Each

person wishing to volunteer contacts a dedicated staff person who will then direct them to a central receiving area for transport to the scene where they can receive personal protective equipment, basic instructions on the work needed, and given appropriate safety training in the work they are about to undertake.

The volunteers are then assigned to competent supervisors who escort them directly to the work areas.

If volunteers are to be utilized during emergency situations, keeping track of who is volunteering and where they have been assigned is essential for safety and for liability purposes. The best method for tracking of the resource is to compile the information in a Volunteer Registration Form. The form should contain the volunteer's name, contact information, assigned duties and a signature. The collection of the information will be responsibility of the Logistics Section Chief and they will appraise the Incident Commander (IC) of the available volunteer resources. The Logistics Chief will also be responsible to schedule the number of volunteers needed by the IC and maintain a log of time on scene as well as any logistical supports (food, transportation, rest locations etc.). Each operational period will require a report of the volunteers that are utilized and provide the information to the IC for command and control.

## 9.0 PLAN EVALUATION, REVIEW and MAINTENANCE

### 9.1 Plan Evaluation and Responsibilities

The Colchester Regional Emergency Management Coordinator (REMC) is responsible for coordinating the annual exercising of the Regional Emergency Management Plan (REMP). The REMP will be evaluated and compiled biennially.

### 9.2 Plan Maintenance and Responsibility

The Colchester REMP will be maintained by the Regional Emergency Management Planning Committee (REMPC) and the Regional Emergency Management Coordinator (REMC).

The REMP will be reviewed biennially and, where necessary, revised by a meeting(s) of the Regional Emergency Management Planning Committee (REMPC) and the Regional Emergency Management Advisory Committee (REMAC). The REMP shall be revised subject to the approval of Municipal Councils.

## 10.0 PLAN DISTRIBUTION

Distributed electronically:

### **Municipal Units**

- Municipality of Colchester
- Town of Truro
- Town of Stewiacke
- Village of Bible Hill
- Village of Tatamagouche

### **Fire and Emergency Services**

- Colchester County Fire Services and Special Hazards Response Unit (SHRU)
- Truro Fire Service
- Stewiacke Fire Department
- Truro Police Service
- Colchester RCMP
- Colchester Ground Search and Rescue

**Colchester Regional Emergency Management Planning Committee members**

**Colchester Regional Emergency Management Advisory Committee members**

## ANNEXES

### Annex A – List of Acronyms

<b>ALERT TC</b>	Alert Truro Colchester
<b>CAO</b>	Chief Administrative Officer
<b>CCRCE</b>	Chignecto Central Regional Centre for Education
<b>CFFA</b>	Colchester Firefighters Association
<b>CGSAR</b>	Colchester Ground Search and Rescue
<b>CNS</b>	Communications Nova Scotia
<b>CRC</b>	Canadian Red Cross
<b>DALAC</b>	Dalhousie University Agricultural Campus
<b>DFAA</b>	Disaster Financial Assistance Arrangement
<b>DOA</b>	Department of Agriculture
<b>DCS</b>	Department of Community Services
<b>DOE</b>	Department of the Environment
<b>DHW</b>	Department of Health and Wellness
<b>DLF</b>	Department of Lands and Forestry
<b>DMA</b>	Department of Municipal Affairs
<b>DTAT</b>	Department of Transportation and Active Transit
<b>ECC</b>	Emergency Coordination Centre
<b>ECCC</b>	Emergency Coordination Centre Commander
<b>ECCMT</b>	Emergency Coordination Centre Management Team
<b>EHS</b>	Emergency Health Services

<b>EM</b>	Emergency Management
<b>EMONS</b>	Emergency Management Organization Nova Scotia
<b>FERP</b>	Federal Emergency Response Plan
<b>HAZMAT</b>	Hazardous Materials
<b>HIRA</b>	Hazard Identification Risk Assessment
<b>HRVA</b>	Hazard Risk Vulnerability Assessment
<b>IAP</b>	Incident Action Plan
<b>IC</b>	Incident Commander (Emergency Site)
<b>ICP</b>	Incident Command Post (Emergency Site)
<b>ICS</b>	Incident Command System
<b>OFM</b>	Office of the Fire Marshal
<b>LO</b>	Liaison Officer
<b>MCC</b>	Municipality of Colchester
<b>MOU</b>	Memorandum of Understanding
<b>NSCC</b>	Nova Scotia Community College (Truro)
<b>NSP</b>	Nova Scotia Power
<b>PCC</b>	Provincial Coordination Centre
<b>PIO</b>	Public Information Officer
<b>PPE</b>	Personal Protective Equipment
<b>PS</b>	Public Safety Canada
<b>PW</b>	Public Works (Municipal)
<b>RCMP</b>	Royal Canadian Mounted Police

<b>REMAC</b>	Regional Emergency Management Advisory Committee
<b>REMC</b>	Regional Emergency Management Coordinator
<b>REMO</b>	Regional Emergency Management Organization
<b>REMPC</b>	Regional Emergency Management Planning Committee
<b>SA</b>	Situational Awareness
<b>SITREP</b>	Situational Report
<b>SO</b>	Safety Officer
<b>SOLE</b>	State of Local Emergency
<b>TARC</b>	Truro Amateur Radio Club
<b>TMR</b>	Truck Mobile Radio
<b>TOS</b>	Town of Stewiacke
<b>TOT</b>	Town of Truro
<b>TFS</b>	Truro Fire Service
<b>TPS</b>	Truro Police Service
<b>VHF</b>	Very High Frequency

## Annex B – List of Definitions

### **Critical Infrastructure**

As one of the priorities for emergency management, critical infrastructure refers to organizations, persons, buildings, and technology considered vital to the health, well-being, and economics of the population.

### **Disaster**

A real or anticipated occurrence such as disease, pestilence, fire, flood, tempest, explosion, enemy attack, sabotage, or release of any commodity which endangers health, safety, and the welfare of the population, property or the environment.

### **Emergency**

A present or imminent event in respect of which a Municipality within Colchester County believes prompt coordination of action or regulation of persons or property must be undertaken to protect property or the health, safety, or welfare of the people of Colchester County region.

### **Emergency Management**

The management of emergencies concerning all-hazards, including all activities and risk management measures related to prevention and mitigation, preparedness, response, and recovery.

### **Emergency Management Plan**

Any plan, program of procedure prepared by Colchester REMO which aims (1) to mitigate the effects of an emergency or disaster, and (2) to safeguard the health or welfare of the population and to protect property and the environment, in the event of an emergency or disaster.

### **Hazard**

A potentially damaging physical event, phenomenon or human activity that may cause the loss of life or injury, property damage, social and economic disruption, or environmental degradation.

### **Impact**

The results or ultimate outcomes of an event or a series of events. When an event occurs, the impact can be measured by examining the event consequences. By continuously asking the questions “so what”, event consequences can be determined.

### **Incident Command System (ICS)**

A standardized on-scene emergency management system specifically designed to provide for the adoption of an integrated organizational structure that reflects the complexity and demands of single or multiple incidents, equipment, personnel, procedures, and communications in operating within a common organizational structure, designed to aid in the management of resources during incidents. ICS is used by various jurisdictions and function agencies, both public and private, to organize field-level incident operations.



**Incident Types** - ICS Definitions Based on complexity, Type 5 least complex, Type 1 the most complex.

#### **Type 5 Incident**

- **Resources:** One or two single resources with up to six personnel. Command and General Staff positions (other than Incident Commander) are not activated.
- **Time Span:** Incident is contained within the first operational period and often within a few hours after resources arrive on scene. A verbal Incident Action Plan (IAP) is required. No written IAP other than Form 201.

#### **Type 4 Incident**

- **Resources:** Command Staff and General Staff functions are activated (only if needed). Several resources are required to mitigate the incident, possibly including a Task Force or Strike Team. The agency administrator may have briefings and ensure the complexity analysis and delegation authority is updated.
- **Time Span:** Limited to one operational period in the control phase. No written Incident Action Plan (IAP) is required, but a documented operational briefing (ICS Form 201) will be completed for all incoming resources.

#### **Type 3 Incident**

- **Resources:** When capabilities exceed initial attack, the appropriate ICS positions should be added to match the complexity of the incident. Some or all Command and General Staff positions may be activated, as well as Division or Group Supervisor and/or Unit Leader positions. An Incident Management Team (IMT) or incident command organization manages the initial action incidents with a significant number of resources, and an extended attack until containment/control is achieved.
- **Time Span:** The incident may extend into multiple operational periods and a written Incident Action Plan may be required for each operational period.

#### **Type 2 Incident**

- **Resources:** Regional and/or national resources are required to manage the safely and effectively operations. Most or all Command and General Staff positions are filled. Operations personnel typically do not exceed 200 per operational period and the total does not exceed 500. The agency administrator official is responsible for the incident complexity analysis, agency administrator briefings, and written delegation of authority.
- **Time Span:** The incident is expected to go into multiple operational periods. A written Incident Action Plan is required for each operational period.

#### **Type 1 Incident**

- **Resources:** This type of incident is the most complex to safely and effectively manage and operate. All Command and General Staff positions are activated. Operations personnel often exceed 500 per operational period and total personnel will usually exceed 1,000. Branches need to be established. The agency administrator official will have briefings and ensure that the complexity analysis and delegation of authority are updated. There is a high impact on the local jurisdiction, requiring additional staff for office administrative and support functions. There may

be provincial or national resource support. A Declaration of a State of Emergency may be made by the appropriate jurisdiction.

- **Time Span:** The incident is expected to go to multiple operational periods. A written Incident Action Plan is required for each operation period.

### **Prevention**

Actions taken to avoid the occurrence of negative consequences associated with a given threat; prevention activities may be included as part of mitigation.

### **Probability**

The frequency or likelihood that an event will happen. This can be measured by historical data and predicted models.

### **Risk**

The combination of the likelihood and the consequence of a specified hazard being realized; refers to the vulnerability, proximity, or exposure to hazards, which affects the likelihood of adverse impact.

### **Risk Management**

The use of policies, practices, and resources to analyze, assess and control risks to health, safety, environment, and the economy.

### **Risk Tolerance**

The degree to which the population or segments of the population can tolerate the chance of a hazard or threat occurring. It is a subjective measure of perception often influenced by experience, media exposure and political agendas.

### **Threat**

The presence of a hazard and an exposure pathway; threats may be natural or human-induced, either accidental or intentional.

### **Vulnerability**

A degree of susceptibility or increased likelihood of being adversely impacted due to the nature of the hazard, time of day of occurrence, or seasonal factors associated with the event.

# Annex C – ECC Activation Guideline

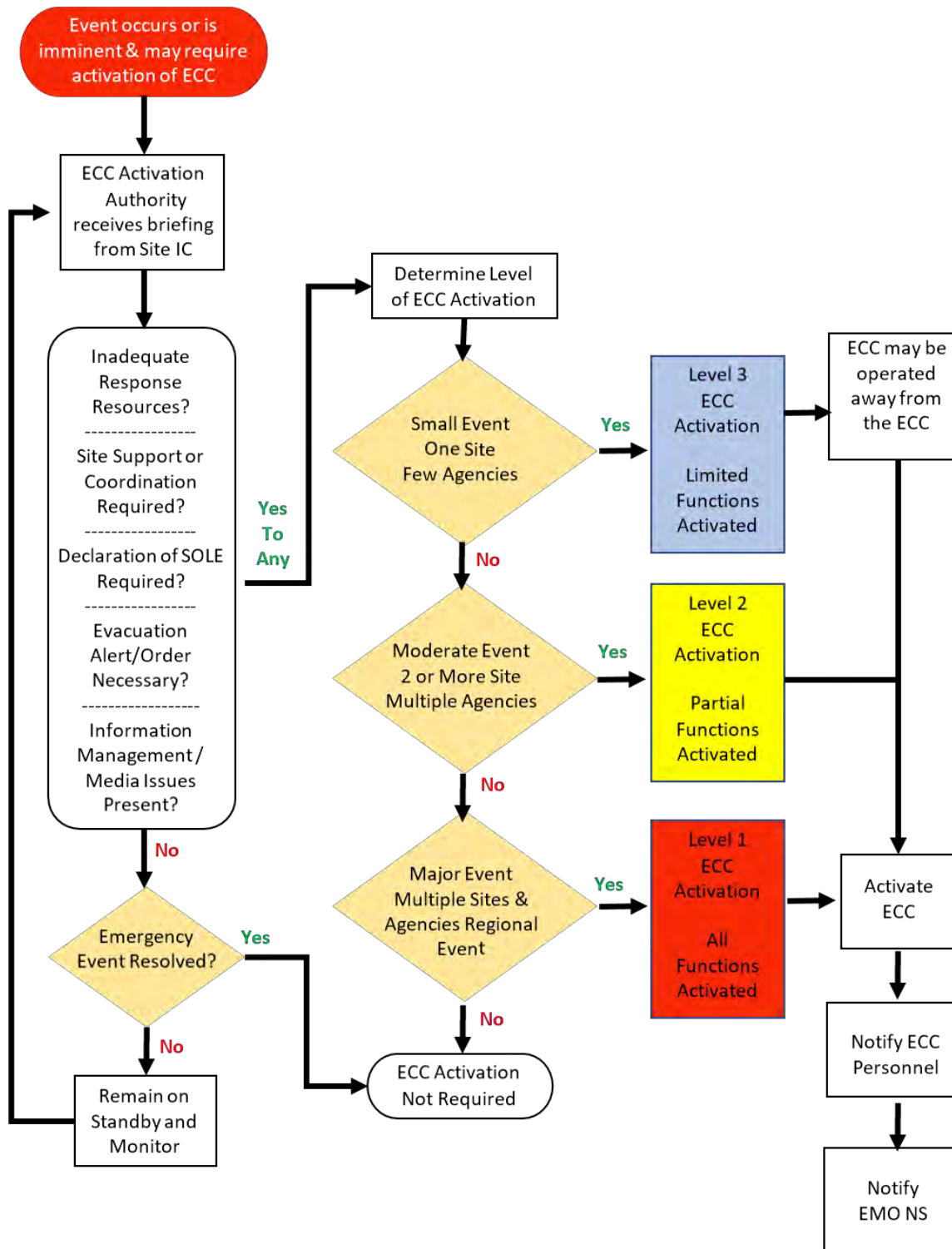

## Annex D – ECC Roles and Responsibilities

### **Emergency Coordination Centre Management Team (ECCMT)**

The primary responsibility of the ECCMT is to provide for the overall management and coordination of site support activities and consequence and recovery management issues. It is the responsibility of the ECCMT to ensure that response priorities are established, and that planning, and response activities are coordinated, both within the ECC (i.e. between sections) and between sites and other ECCs.

The ECCMT consists of the following positions:

- Policy Director (Chair of REMAC)
- ECC Commander
- Public Information Officer
- Safety Officer
- Liaison Officer
- Operations Section Chief
- Planning Section Chief
- Logistics Section Chief
- Finance and Administration Section Chief

### **Policy Director**

The Policy Director is the Chair, or designate, of the Regional Emergency Management Advisory Committee (REMAC). Responsibilities of the Policy Director include:

- Acting as liaison between the Emergency Coordination Centre Manager (ECCM) and Municipal Councils.
- Declaration/termination of an emergency.
- Bringing recommendations for changing/amending Emergency Management Plans, bylaws or policies to the REMAC with the assistance of Kings REMO staff.
- Official spokesperson, if required.
- Ensuring Members of Municipal Councils are notified of the emergency.
- Notifying the Mayors of the affected and/or adjoining municipalities of the emergency, if required and providing any status reports.

### **ECC Commander (CAO)**

This position is filled by a Municipal CAO, or designate, and has overall authority and responsibility for the activities of the ECC which include:

- Assess the Situation – Gather information about the emergency. Assess the magnitude and severity of the situation to determine the appropriate level of ECC activation.
- Support Site(s) – Provide support to Incident Commanders and Support Agencies, and ensure that all actions are coordinated within the established priorities.
- Develop / Approve Action Plans – Prepare ECC action plans with the ECCMT based on an assessment of the situation and available resources. Set priorities and response objectives for affected areas.

- Inform Others – In consultation with the Information Officer, assist emergency information actions using the best methods of dissemination. Approve press releases and other public information materials. Keep the Policy Group informed.
- Manage the ECC – Establish the appropriate ECC staffing level and continuously monitor organizational effectiveness.
- Liaise with the Incident Commander - Confirm the geographical boundaries of the emergency area.
- Confirming the adequacy of the expenditure limits.

#### **Safety Officer**

- Ensures good risk management practices are applied throughout the response and recovery and that every function within the ECC considers the management of risk.
- Identifies liability and loss exposures to personnel and property.
- Provides informed opinion on probabilities and potential consequences of future events and matters related to legal obligations and how they may be applicable to the actions of Colchester REMO during the emergency.
- Provides advice on health and safety issues and if required.

#### **Liaison Officer**

- Invites required or requested Support Agencies and stakeholders to the ECC, as identified by the ECC Commander and ECC Management Team (ECCMT) and maintains contact when required.
- Provides input on the strategic direction and advice to the ECCMT regarding emergency management issues.
- Liaises with the neighbouring Municipal and Regional EMCs and other provincial and federal representatives, as required.
- In conjunction with the ECC Manager, facilitates a debriefing with the ECC personnel and other appropriate Support Agencies and prepares an after-action report on the emergency.

#### **Public Information Officer**

- Establishes and maintains media contacts.
- Prepares news/social media releases, coordinating interviews, news conferences, and/or media briefings.
- Develops public information materials, providing messaging for use by 211 and ECC staff.
- Establishes communications strategies for internal and external purposes.
- Monitors media and information sources including 211.
- Liaises and coordinates messages with other internal and external Public Information Officers.
- Ensures public safety information is provided in accessible formats as required by provincial legislation.

#### **Operations Section Chief**

The ECC Operations Section Chief coordinates resource requests, resource allocations, and response operations in support of Incident Commanders at one or more sites.

- Maintain Communications – Establish communication links with incident command posts and

the ECC if activated.

- Participate in ECCMT Meetings – Prepare section objectives for presentation at ECCMT meetings, at least once in each operational period.
- Coordinate Response – Direct the coordination of operations in cooperation with other Support Agencies.
- Coordinate Resource Requests – Collect and coordinate resource requests from site(s), working with the ECC Logistics Section.
- Share Operational Information – Collect and distribute operational information to the planning section, the ECC Information Officer, and other ECC Sections.
- Manage the Operations Section – Establish the appropriate Operations Section or divisions and continuously monitor organizational effectiveness.

### **Branch Coordinators**

Branch Coordinators oversee the operations of a particular department, division, section, or agency. A Branch Coordinator will be responsible for coordinating the activities of their Department/Support Agency site personnel and dispatch centre (if one exists). Additional branch staff may be needed, dependent on the size of the emergency event and the support required. Branch Coordinators may include, but are not limited to:

- Fire Branch Coordinator
- Police Branch Coordinator
- EHS Branch Coordinator
- Emergency Social Services Branch Coordinator
- Public Works Branch Coordinator
- Public Health Branch Coordinator

### **Planning Section Chief**

The Planning Section is responsible to:

- Assess the Situation – Gather information about the emergency. Collect, analyze, and display situation information. Prepare periodic situation reports.
- Manage the Planning Section – Establish the appropriate Planning Section Unit and continuously monitor organizational effectiveness.
- Participate in ECCMT Meetings – Prepare section objectives for presentation at ECCMT meetings, at least once in each operational period.
- Managing Display Boards - Ensure that the situation unit is maintaining current information for the ECC situation report.
- Anticipate Future Events – Conduct advance planning activities to forecast possible events and requirements beyond the current operational period. Report recommendations to the ECCMT.
- Track Resources – Track resources assigned to the ECC and to the Incident Commanders through the ECC and mutual aid.
- Keep Records – Document and maintain paper and electronic files on all ECC activities.
- Plan for ECC Demobilization – Set out a schedule for demobilization and assist Section Chiefs in debriefing ECC personnel as they leave.

- Plan for Recovery – Initiate recovery efforts at the earliest time and develop plans for short-term and long-term recovery appropriate to the needs.
- Coordinate Technical Specialists – Provide technical support services to ECC sections and branches, as required.
- Prepare After Action Report – Coordinate the assembly of ECC lessons learned from contributions from ECC staff and from Support Agency representatives.

#### **Logistics Section Chief**

- Manage the Logistics Section – Establish the appropriate Logistics Section Units and continuously monitor organizational effectiveness.
- Provide Telecommunication and Information Technology Services – Support use of telecommunication and information technology in ECC.
- Support ECC – Provide and maintain ECC facilities, including all utilities, food, water, and office supplies.
- Supply Equipment and Material Resources to Sites – Coordinate all requests for resources from initiation to delivery to support operations section.
- Participate in ECCMT Meetings – Prepare section objectives for presentation at ECCMT meetings, at least once in each operational period.
- Coordinate Personnel – Acquire and assign personnel with the appropriate qualifications to support site requests. Develop systems to manage convergent volunteers.
- Arrange Transportation – Coordinate transportation requests in support of response operations.

#### **Finance and Administration Section Chief**

- Record Personnel Time – Collect and process on-duty time for all ECC personnel, including volunteers and Support Agency representatives. Ensure uninterrupted payrolls for all employees.
- Coordinate Purchasing – Control acquisitions associated with emergency response or recovery, including purchase orders and contracts in consultation with the Risk Management Officer.
- Coordinate Compensation and Claims – Process workers' compensation claims within a reasonable time.
- Participate in ECCMT Meetings – Prepare section objectives for presentation at ECCMT meetings, at least once in each operational period.
- Record Costs – Maintain financial records for response and recovery throughout the event. Keep the ECC Commander, ECCMT, and elected officials aware of the current fiscal situation.
- Maintain Records – Ensure that all financial records are maintained throughout the event or disaster.

## **Fire Service**

**Role:** In addition to the normal role of firefighting, the fire service is also expected to perform the task of rescuing trapped or injured people in a non-fire emergency.

**Responsibilities:** During an emergency, the fire service is responsible for:

- a) The coordination of firefighting and rescue operations;
- b) The activation of the mutual aid agreement, if necessary;
- c) The activation of all necessary fire brigade department emergency response systems;
- d) The establishment of an on-site command post;
- e) The establishment of adequate communications;
- f) The protection of life, property and the environment;
- g) Determining the need and arranging for supplementary water supplies;
- h) The providing of assistance in rescue operations from buildings and wreckage;
- i) Requesting ambulance service and providing assistance as required;
- j) Contacting the Special Hazards Response Unit should oil or chemicals be involved and taking appropriate action until they arrive;
- k) Initial crowd and traffic control if the fire service is first on the scene;
- l) The establishment of a control perimeter at the immediate emergency scene.

## **Fire Service Representative**

**Responsibilities:** The Fire Service representative or alternate are responsible to:

- a) Maintain an up-to-date listing of all available fire brigade/ department resources with a copy to be filed with the REMC.
- b) Be well versed on fire brigade/ departmental resources which include equipment and fire hall facilities;
- c) Maintain current copies of any or all fire Mutual Aid Agreements in effect in the Colchester County Region with a copy to be filed with the REMC.
- d) Be knowledgeable in the latest of firefighting equipment, procedures and operations;
- e) Advise members of the ECC on the fire service and be prepared to make recommendations as required;
- f) Communicate to the on-site fire command any special objectives of the ECC.
- g) Maintain a log with time and date of all actions taken.



## **Police Service**

**Role:** The police will perform their normal police duties at an emergency as well as coordinate activities of Ground Search and Rescue and Animal Control.

**Responsibilities:** During an emergency, the police service is responsible for:

- a) The protection of life and property;
- b) The control of people and traffic;
- c) The requesting of ambulance and fire service as required;
- d) The establishment of an on-site command post if required;
- e) The establishment of adequate communications;
- f) Activating any Police Emergency Plans;
- g) The establishment of a control perimeter at the immediate emergency scene, and if necessary, disperse and control crowds, and secure area;
- h) The overall control of evacuations of areas authorized by the Emergency Coordination Centre;
- i) The establishment of control routes for evacuation and emergency vehicles;
- j) The provision of security, guard against unauthorized re-entry and looting of the evacuated areas;
- k) The provision of police personnel at assembly areas or relocation centers as required;
- l) The notification of the coroner of fatalities and the establishing of temporary morgue if necessary;
- m) Assisting in search and rescue operations and coordination of Ground Search and Rescue Teams;
- n) The coordination with Animal Control for the movement, relocation, or destruction of animals in the evacuation area.

## **Police Service Representative**

**Responsibilities:** The police service representative or alternate is responsible to:

- a) Maintain an up-to-date listing and be knowledgeable of available police resources;
- b) Liaison with municipal, provincial and federal police resources;
- c) Provide communications between the ECC and the police services;
- d) Advise members of the ECC on the police matters and be prepared to make recommendations as required;
- e) Communicate to on-site police command any special objectives of the ECC;
- f) Maintain a log of all actions taken.

## **Ground Search and Rescue Organization**

When an evacuation order is in effect, the Ground Search and Rescue Organization under the direction of the Police Service will be responsible for the following:

- a) To provide trained search and rescue personnel to assist the police in search and rescue activities;
- b) To provide trained personnel to assist the police service in evacuation activities e.g. door to door to alert residents of the need to evacuate, provide first aid, help in assembly area(s) and oversee the loading buses;
- c) Place at the disposal of the police service; personnel, rescue and communications equipment;
- d) Provide trained search and rescue personnel and equipment at the request of and under the direction of the fire services.

## **Transportation Service**

**Role:** The role of the transportation service is to provide and control the emergency transportation of people.

**Responsibilities:** During an emergency, the transportation service is responsible for:

- a) The direction and coordinated control over all public transportation;
- b) The immediate and ongoing transportation needs to move people from evacuation area to relocation centres;
- c) To act as a liaison with bus companies, taxis and any other mode of transportation;
- d) The provision of specialized buses to aid in the evacuation of hospitals or life institutions;
- e) To maintain service in non-affected areas.

## **Transportation Service Representative**

**Responsibilities:** The transportation service representative or alternate is responsible for:

- a) Maintain an up-to-date listing of resources for emergency public transportation, with a copy to be filed with the EMC;
- b) The coordination with emergency officials if the movement of emergency personnel should be required;
- c) Advise the members of the ECC on matters relative to emergency public transportation and be prepared to make recommendations as required;
- d) Maintain a log with time and date of all actions taken.

## **Public Works Departments**

**Role:** The Public Works Departments will support emergency operations by providing engineering services, equipment, and manpower.

**Responsibilities:** During an emergency, the Public Works Departments will be responsible to:

- a) Activate their respective emergency services plan;
- b) Provide municipal equipment, supplies and personnel as required;
- c) Provide and up-to-date list with phone numbers of equipment, supplies, suppliers of materials, construction companies, private contractors and engineering resources, etc.;
- d) Act as liaison with Water Utilities, Nova Scotia Power, Telephone Companies, Cable Companies and Gas Companies for the disconnect of services that represent a hazard and for the restoration of service when it is safe to do so;
- e) Arrange for the necessary tests to determine the degree of any potential explosive, flammable, or toxic agents and arrange for the elimination of same with municipal infrastructure;
- f) Provide assistance in clean-up operations and repair damage where there is a municipal responsibility to do so;
- g) Provide barricades and flashers on request;
- h) Provide and post directional and/or information signage as requested;
- i) Provide auxiliary and/or emergency lighting as requested;
- j) Provide alternate sanitation facilities if required;
- k) Provide assistance in search and rescue operations if required;
- l) Protect life, property and the environment.

## **Public Works Representative**

**Responsibilities:** The public works department's representatives or alternates are responsible to:

- a) Maintain an up-to-date listing with phone numbers of special equipment such as backhoes, bulldozers, generators, trucking equipment, pumps, excavators, air- compressors, cranes, construction materials, portable toilets, etc., with a copy to be filed with the EMC;
- b) Maintain an up-to-date list of emergency contact names and phone numbers for Water Utilities, Nova Scotia Power, Phone Companies, Cable Companies and Gas Companies with a copy to be filed with the EMC;
- c) Advise members of the Emergency Management Planning Committee on municipal service matter and be prepared to make recommendations as required;
- d) Advise members of the ECC on municipal service during an emergency and prepared to make recommendations if required;
- e) Coordinate municipal services during an emergency and communicate objectives of the ECC to municipal staff;
- f) Maintain a log with time and date of all actions taken.

## **Department of Community Services / Canadian Red Cross**

### **Preamble:**

Through the agreement initially signed April 2000 Department of Community Services (DCS) and Canadian Red Cross (CRC) work together in the prior planning, training & preparedness for an emergency or disaster for the provision of Emergency Social Services in an emergency or disaster. The six Emergency Social Services are Food, Clothing, Shelter, Reception and Information, Registration, and Inquiry and Personal Services.

### **Preplanning:**

CRC prepares and provides ongoing orientation and training in the six Emergency Social Services to all appropriate Red Cross personnel involved in emergency preparedness in Nova Scotia. CRC negotiates and provides ongoing orientation and training to community Emergency Social Service partners, enabling those groups to integrate into the overall Red Cross emergency plan. These would include such groups as the Salvation Army, St John Ambulance, Association of Food Banks, grocery, and hotel chains, etc. In consultation with DCS Regional Coordinators, meets with each Municipal Emergency Management Coordinator in their region on a regular basis to ensure Emergency Social Service is a part each Municipality's emergency plan and to provide clarification on DCS/CRC roles and responsibilities in pre-response, response, and post-response situations. This includes being involved with the Municipalities' emergency exercise, etc.

### **Response (Red Cross):**

Call out of Canadian Red Cross under Department of Community Services normally occurs when there has been an evacuation of a minimum of 10 units or 25 people. When called by Municipal EMO personnel, the Canadian Red Cross responds immediately to the emergency site, designated reception centre(s) and/or the locally designated emergency operations centre whichever is most appropriate for the emergency situation. In most situations where CRC is called first EMO, the CRC and/or the EMC will call DCS to inform them of the emergency to ensure availability of resources and consistent communication. The CRC will manage designated reception centres/shelters and provide sufficient personnel resources to cover all six Emergency Social Services throughout the duration of the emergency. The CRC is the agency responsible for the domestic Disaster Animal Response Team (DART).

### **Contact Details:**

Situations requiring immediate access to the Canadian Red Cross can be received, on a 24 hour/7day per week basis, at the Canadian Red Cross' emergency number (1-800-222-9597). This is not a number for the distribution to the general public. It is for municipalities' emergency staff to use in times of emergency.

## Annex E – Evacuation Considerations

### Decision/Evacuation Phases

<b>Situational Awareness</b>	<ul style="list-style-type: none"> <li>• Scale of Threat</li> <li>• Current and Predictive Information</li> <li>• Accuracy and Validity of Information</li> </ul>
<b>Consequences</b>	<ul style="list-style-type: none"> <li>• Level of Impact</li> <li>• Degree of Injury/Damage</li> <li>• Political/Media Interest</li> <li>• Effect of/on Actions or Inactions</li> </ul>
<b>Timing</b>	<ul style="list-style-type: none"> <li>• Predicted Time of Onset or Impact</li> <li>• Estimated Time to Undertake Warning</li> <li>• Estimated Time to Undertake Evacuation</li> <li>• Duration of Evacuation</li> </ul>
<b>Human Resources</b>	<ul style="list-style-type: none"> <li>• Door-to-door Teams</li> <li>• Evacuation Centre Management Teams</li> <li>• Assembly Area Personnel</li> <li>• Disaster Victim Registration Teams</li> </ul>
<b>Physical Resources</b>	<ul style="list-style-type: none"> <li>• Transportation Points</li> <li>• Traffic Management</li> <li>• Signage/Barriers</li> <li>• Assembly Areas</li> <li>• Animal Shelters</li> </ul>
<b>Governance</b>	<ul style="list-style-type: none"> <li>• Emergency Plan</li> <li>• Local Evacuation Plan</li> <li>• Hazard Specific Sub-Plan</li> <li>• Operational Procedures/Guidelines</li> </ul>
<b>Specific Populations</b>	<ul style="list-style-type: none"> <li>• Vulnerable and Transient Groups</li> <li>• Cultural</li> <li>• Level of Resilience/Preparation</li> </ul>
<b>Health and Safety Risks</b>	<ul style="list-style-type: none"> <li>• To Evacuees and Responders</li> <li>• Medical Issues</li> </ul>
<b>Consultation</b>	<ul style="list-style-type: none"> <li>• Support Agencies</li> <li>• Affected and Receiving Communities</li> <li>• Other Experts</li> </ul>
<b>Public Messaging</b>	<ul style="list-style-type: none"> <li>• Early Advice</li> <li>• Timings</li> <li>• Areas Identified</li> </ul>
<b>Options</b>	<ul style="list-style-type: none"> <li>• No Evacuation</li> <li>• Staged Movement</li> <li>• Shelter-in Place</li> <li>• Self-Managed</li> <li>• Prepare to Evacuate</li> <li>• Mass Movement</li> </ul>

## Re-Entry Phases

<b>Hazards and Damage</b>	<ul style="list-style-type: none"> <li>• Presence or Possible Return of Hazard</li> <li>• New/Secondary Hazards</li> <li>• Impact Assessment</li> <li>• Structural Integrity &amp; Major Infrastructure</li> </ul>
<b>Health</b>	<ul style="list-style-type: none"> <li>• Public Health Risks</li> <li>• Safety of Returning Evacuees &amp; Responders</li> <li>• Provision of Mental &amp; Physical Health Services</li> </ul>
<b>Business &amp; Other Services</b>	<ul style="list-style-type: none"> <li>• Essential Services</li> <li>• Commercial Services</li> <li>• Local Government Services</li> <li>• Transportation Infrastructure</li> </ul>
<b>Human Resources</b>	<ul style="list-style-type: none"> <li>• Escorting Personnel</li> <li>• Traffic Management Points/Exclusion Areas</li> <li>• Outreach Teams &amp; Other Support Services</li> <li>• Recovery Centre Personnel</li> </ul>
<b>Physical Resources</b>	<ul style="list-style-type: none"> <li>• Transportation</li> <li>• Signage/Barriers</li> <li>• Crime Scene Preservation</li> <li>• Recovery Centre</li> </ul>
<b>Governance</b>	<ul style="list-style-type: none"> <li>• Emergency Management Plan</li> <li>• Impact Assessment</li> <li>• Demobilization of Resources/Services</li> <li>• Recovery Plan</li> <li>• Operational Procedures/Guidelines</li> </ul>
<b>Vulnerable Groups &amp; Facilities</b>	<ul style="list-style-type: none"> <li>• Level of Readiness to Return</li> <li>• Hospitals &amp; Aged Care Facilities</li> <li>• Education Facilities Ability to Function</li> </ul>
<b>Timings</b>	<ul style="list-style-type: none"> <li>• Commencement of Re-Entry</li> <li>• Estimated Time to Undertake Re-Entry</li> <li>• Removal of Personnel/Services Providing Re-Entry Assistance</li> <li>• Exit Strategy</li> </ul>
<b>Consultation</b>	<ul style="list-style-type: none"> <li>• Support Agencies</li> <li>• Affected Community</li> <li>• Functional Areas</li> <li>• Local Government</li> <li>• Police Services</li> </ul>
<b>Public Information</b>	<ul style="list-style-type: none"> <li>• Return Arrangements</li> <li>• Recovery &amp; Support Services</li> <li>• Safety Advice</li> <li>• Timings</li> </ul>
<b>Options</b>	<ul style="list-style-type: none"> <li>• Restricted Re-Entry</li> <li>• Unrestrictive Re-Entry</li> <li>• Staged Re-Entry</li> </ul>



Annex F – Potential Evacuation Routes – Central Colchester Flood Risk Areas

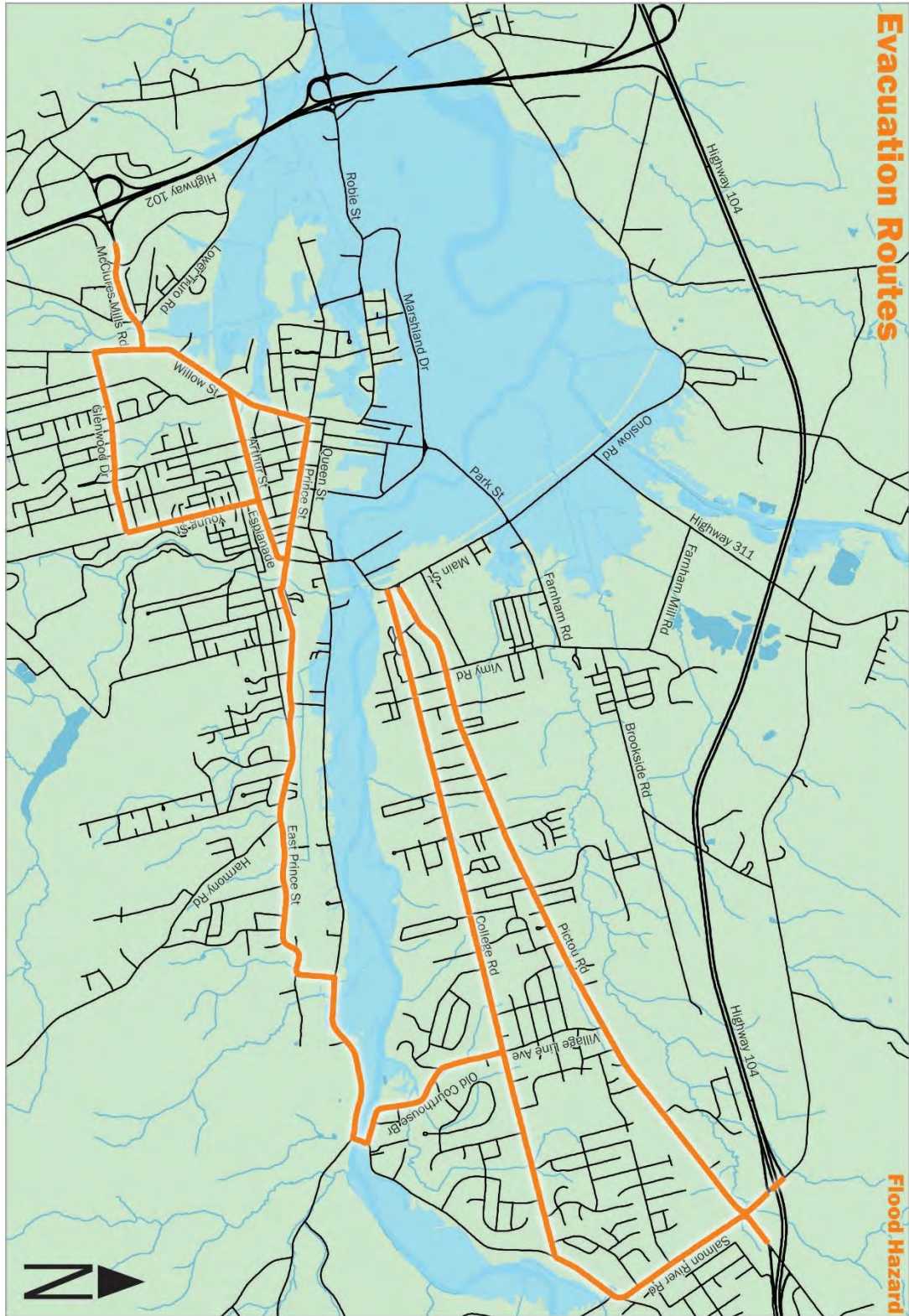



## Annex G – Emergency Public Information Plan

### **Preamble**

During an emergency event, communication with the community becomes critical. Emergency communications may include alerts and warnings, directives about evacuations and other self-protective actions, and information about response status, available assistance, and other matters that impact response and recovery. These essential communications directives are the responsibility of the Public Information Officer (PIO) and the position is tasked with crafting the messages that will inform the community of the on-going status of the response and recovery.

Well constructed and effectively delivered emergency messages can help public safety, protect property, and instill public confidence. The extent of which people respond to a warning message is influenced by a variety of factors including the individuals' perceptions, if the message is from a credible source, the way the message is delivered and the message itself.

### **Importance and Functions**

Emergency communication is critical information that could mean the difference between life and death. It becomes as vital as food and water to the community. Information can provide reassurance that the response and recovery are occurring.

Emergency public information can serve in many functions:

- Save lives and reduce injury – Knowing the appropriate actions to take enables the population to reduce their risks.
- Protect property and the environment – Mitigating risk to property and the environment may lessen the damage caused by an emergency.
- Facilitate the planned response – Calms fears and attempts to manage expectations. Advising the population of what to expect could ensure that the population may follow instructions and allow emergency responders to perform their duties.
- Educate and inform – When people are educated, they are more likely to be prepared for emergencies and ready when they occur.
- Seek the public's cooperation – If volunteer help is needed, citizen's cooperation or if residents need to evacuate their homes or businesses, emergency public information is the device that make it happen.
- Instill public confidence – Providing timely, accurate and understandable information will build confidence in the emergency management team's ability to manage the emergency event.
- Provide information to assist the public – Information about emergency facilities will support the public by directing the population to the closest registration centre, comfort centre or shelter.

### **Challenges**

Emergency public information is different than routine communications that are often released by municipal units. The release of emergency public information has a specific purpose and that is to prompt a specific response rather than raising awareness.

This type of communication often encounters challenges and barriers. The barriers can be formed as it can be difficult for people to process the messages during an emergency. The challenges can be from the stress of the event and changes to people's routines. Language and literacy barriers need to be overcome when crafting a message. Some populations may have English as their second language and unfortunately, there are people in the community that may have some obstacles with literacy comprehension.

Emergency communications must be timely and appropriate. If official answers are not available, rumor and speculation quickly fill the void. The void then becomes filled with whomever chooses to provide it and the emergency management team must disseminate correct information and counter any misinformation that has been circulated.

### **Communication Tools**

As the emergency information strategy is being developed, the PIO and their team will evaluate all the available communication options for the message delivery.

In-Person Events. These events such as media briefings can be used to provide information to the public and the media. Briefings are a powerful tool to communicate and distribute emergency information.

Print Media. Print media is a communication platform that is experiencing some significant changes as the physical printed page is transitioning to websites. Regardless of the method of how the information is distributed, it is not a good tool if the emergency information is time critical. It can be a good tool if in-depth information needs to be circulated that is not time sensitive.

Broadcast Media. Television and radio can be used to present information quickly through the Alert Ready Emergency Alert System, public service announcements (PSA) and news programming.

Mass Notification Software and Emergency Alert System. The region currently is utilizing a mass notification software called Alert Truro Colchester (Alert TC) that can notify the enrolled subscribers of emergency notifications through telecommunications, email, and smartphone/tablet applications. In 2019, Alert TC was first used to broadcast information on Hurricane Dorian. Colchester REMO could also request a broadcast of the Alert Ready Emergency Alert System through EMO NS. Alert Ready can broadcast emergency notifications via radio, television, satellite/cable, and cellular providers. Any message that is requested through the Alert Ready platform will be required to meet specific criteria.

Social Media and Internet. These mediums can provide immediate message delivery over a wide range of formats. Websites can deliver many types of media and accessibility features, but the public needs to access the site. Social media includes web-based and mobile technologies that can deliver instantaneous messaging to those who have access.

## **Best Practices and Pitfalls**

As the emergency event develops and unfolds, there are actions that need to be established and avoided.

### Best Practices

- Have a designated spokesperson.
- Release only verified information and ensure that the message is approved by the IC for publication.
- Promptly alert of relief and recovery.
- Have a clear understanding of what can and cannot be released.
- Keep accurate records and logs of all inquiries and media coverage.
- Become educated on media's deadlines.
- Provide equal opportunities and facilities for broadcast and social media platforms.
- When conditions permit; escort media to the emergency site.
- Carefully coordinate implementation of emergency public information activities with other aspects of the developing emergency plan.

### Pitfalls

- Refrain from idly speculating on the cause of the emergency.
- Do not speculate on the resumption of normal operations.
- Do not speculate on the outside effects of the emergency.
- Do not speculate on the dollar value of losses.
- Refrain from interfering with the legitimate duties of the media.
- Do not permit unauthorized spokespersons to comment to the media or post on social media.
- Do not attempt to cover up or purposely mislead the media or the public.
- Do not attempt to place blame for the emergency.

## **Media Centre**

The Colchester REMO has a dedicated Media Centre for press briefings. This venue is at the Village of Bible Hill's Administration Building located at 67 Pictou Road.

## **How to Format a News Release**

- Always double space between each line of text and print on only one side of the paper;
- Put "FOR IMMEDIATE RELEASE" or indicate release time at the top of the first page;
- Drop two lines and write a brief descriptive headline;
- Drop two lines and begin the news release text with a dateline, giving the location where the news is originating and the date;
- End all but the last page with the word "more" centred below the last line of text;
- Never end a page in the middle of a paragraph;
- Centre "-30-" below the last line of text;
- Put the name and phone numbers of one or more contact people at the bottom of the last page.

## **What the Media may ask in an Emergency?**

During emergencies, the Public Information Officer should be prepared to respond to questions about the following:

### Casualties:

- Number injured.
- Number who escaped.
- Nature of the injuries received.
- Care given to the injured.

### Property Damage:

- Estimated value of loss.
- Description (kind of building, etc.)
- Importance of property (historic value, wildlife area, etc.)
- Other property threatened.
- Previous emergencies in the area.

### Causes:

- Statement of witnesses, those involved and key first responders (fire, police, medical, etc.)
- How emergency was discovered?
- Who sounded the alarm?
- Who summoned aid?
- Previous indications of dangers.

### Rescue and Relief:

- The number engaged in rescue and relief operations.
- Any prominent persons in the relief crew.
- Equipment used.
- Anything that hindered rescue operations.
- Care of destitute and homeless.
- How the emergency was prevented from spreading.
- How was the property saved?

### Description of the Crisis or Disaster:

- Spread of the emergency.
- Blasts or explosions.
- Crimes or violence.
- Attempts at escape or rescue.
- Duration.
- Collapse of structures.
- Extent of any spills.

#### Accompanying incidents:

- Number of spectators
- Spectator attitudes and crowd control
- Unusual happenings
- Anxiety, stress of families, survivors, etc.

#### Legal Actions:

- Police follow-up.
- Insurance company actions.
- Professional negligence or inaction.
- Lawsuits stemming from the incident.

#### How the Media can Help

- Assist in pre-emergency education.
- Warn the public of the emergency.
- Reinforce the warning to the public.
- Get your requests out to the public.
- Get information out to the public.
- Get your point of view to the public.
- Reassure the public.
- Secure needed help for the response.
- Generate needed outside help.

#### **Activation**

The Public Information Officer (PIO) will work in conjunction with the Regional Emergency Management Coordinator (REMC) and/or the alternate REMC at the onset of any potential emergency. The role of the PIO becomes paramount as the emergency unfolds and the Emergency Coordination Centre (ECC) activates. The position then will coordinate all public awareness statements and press releases on the emergency response and recovery. The PIO will require all messaging to be vetted and sanctioned by the ECC Commander and will work alongside other agency PIOs and Communication Nova Scotia.

Annex H – State of Local Emergency Forms (SOLE)

**FORM 4  
DECLARATION A STATE OF LOCAL EMERGENCY**

Municipality: \_\_\_\_\_

**Section 12(2) of the *Emergency Management Act*, S.N.S 1990, c.8**

**WHEREAS** the area herein described is or may soon be encountering an emergency that requires prompt action to protect property or health, safety or welfare of persons therein:

**Emergency Area:**

The area generally described as

\_\_\_\_\_

Province of Nova Scotia (hereafter referred to as the "Designated Area(s)") Yes ( ) No ( )

**Nature of the Emergency**

\_\_\_\_\_

\_\_\_\_\_

\_\_\_\_\_

**AND WHEREAS** the undersigned is satisfied that an emergency as defined in Section 2(b) of Chapter 8 of the Statutes of Nova Scotia, 1990, the *Emergency Management Act*, exists or may exist in the Designated Area(s) noted above;

**THE UNDERSIGNED HEREBY DECLARES** pursuant to Section 12(2) of the *Emergency Management Act*, a State of Local Emergency in the Municipality noted above as of and from \_\_\_\_\_ o'clock in the forenoon ( ) or afternoon ( ) of the day of \_\_\_\_\_, 20\_\_\_\_ .

**THIS DECLARATION OF STATE OF LOCAL EMERGENCY** shall exist until o'clock in the forenoon ( ) or afternoon ( ) of the day of \_\_\_\_\_, 20\_\_\_\_, or for a maximum of 7 days from the date and time specified above unless the Declaration is renewed or terminated as provided in Section 20 of the *Emergency Management Act*.

DATED at \_\_\_\_\_, in the Municipality of \_\_\_\_\_, Province of Nova Scotia, this day of \_\_\_\_\_, 20\_\_\_\_ .

Council, Municipality \_\_\_\_\_

Name \_\_\_\_\_

Positions \_\_\_\_\_

[Authorized by Resolution No. \_\_\_\_\_

dated the Day of \_\_\_\_\_, 20\_\_\_\_]

**FORM 5  
DECLARATION A STATE OF LOCAL EMERGENCY**

Municipality: \_\_\_\_\_

**Section 12(2) of the *Emergency Management Act*, S.N.S 1990, c.8**

**WHEREAS** the area herein described is or may soon be encountering an emergency that requires prompt action to protect property or health, safety or welfare of persons therein:

**Emergency Area:**

The area generally described as

\_\_\_\_\_

Province of Nova Scotia (hereafter referred to as the "Designated Area(s)") Yes ( ) No ( )

**Nature of the Emergency**

\_\_\_\_\_  
\_\_\_\_\_  
\_\_\_\_\_

**AND WHEREAS** the undersigned is satisfied that an emergency as defined in Section 2(b) of Chapter 8 of the Statutes of Nova Scotia, 1990, the *Emergency Management Act*, exists or may exist in the Designated Area(s) noted above;

**AND WHEREAS** the Council of the Municipality is unable to act;

**AND WHEREAS** the undersigned has (check appropriate box)

- |  |         |        |
|--|---------|--------|
| a) Consulted with a majority of members of the Municipal Emergency Management Committee              | Yes ( ) | No ( ) |
| b) Found it impractical to consult with the majority of the Municipal Emergency Management Committee | Yes ( ) | No ( ) |

**THE UNDERSIGNED HEREBY DECLARES** pursuant to Section 12(2) of the *Emergency Management Act*, a State of Local Emergency in the Municipality noted above as of and from \_\_\_\_\_ o'clock in the forenoon ( ) or afternoon ( ) of the day of \_\_\_\_\_, 20\_\_\_\_ .

**THIS DECLARATION OF STATE OF LOCAL EMERGENCY** shall exist until o'clock in the forenoon ( ) or afternoon ( ) of the day of \_\_\_\_\_, 20\_\_\_\_, or for a maximum of 7 days from the date and time specified above unless the Declaration is renewed or terminated as provided in Section 20 of the *Emergency Management Act*.

DATED at \_\_\_\_\_, in the Municipality of \_\_\_\_\_, Province of Nova Scotia, this day of \_\_\_\_\_, 20\_\_\_\_ .

Mayor Signature \_\_\_\_\_  
Municipality \_\_\_\_\_



**FORM 6  
RENEWAL OF A STATE OF LOCAL EMERGENCY**

Municipality: \_\_\_\_\_

**Section 20 (2) of the *Emergency Management Act*, S.N.S 1990, c.8**

**WHEREAS** the area herein described is or may soon be encountering an emergency that requires prompt action to protect property or health, safety or welfare of persons therein:

**Emergency Area:**

The area generally described as

\_\_\_\_\_

Province of Nova Scotia (hereafter referred to as the "Designated Area(s)") Yes ( ) No ( )

**Nature of the Emergency**

\_\_\_\_\_

\_\_\_\_\_

\_\_\_\_\_

**AND WHEREAS** the declaration of a state of Local Emergency was signed on the \_\_\_\_\_ day of \_\_\_\_\_, 20\_\_\_\_;

**AND WHEREAS** the undersigned is satisfied that an emergency as defined in Section 2(b) of Chapter 8 of the statutes of Nova Scotia, 1990, the *Emergency Management Act*, exists or may exist in the Designated Area(s) noted above;

**THE UNDERSIGNED HEREBY DECLARES** pursuant to Section 20(2) of the *Emergency Management Act*, a State of Local Emergency in the Municipality noted above is renewed as of and from \_\_\_\_\_ o'clock in the forenoon ( ) or afternoon ( ) of the day of \_\_\_\_\_, 20\_\_\_\_ .

**THE RENEWAL OF A DECLARATION OF STATE OF LOCAL EMERGENCY** shall exist until o'clock in the forenoon ( ) or afternoon ( ) of the day of \_\_\_\_\_, 20\_\_\_\_, or for a maximum of 7 days from the date and time specified above unless the Declaration is renewed or terminated as provided in Section 20 of the *Emergency Management Act*.

DATED at \_\_\_\_\_, in the Municipality of \_\_\_\_\_, Province of Nova Scotia, this day of \_\_\_\_\_, 20\_\_\_\_ .

Council, Municipality \_\_\_\_\_

Name \_\_\_\_\_

Positions \_\_\_\_\_

[Authorized by Resolution No. \_\_\_\_\_

dated the Day of \_\_\_\_\_, 20\_\_\_\_]

In the event the Council is unable to act:

Mayor \_\_\_\_\_

**FORM 7  
TERMINATION OF A STATE OF LOCAL EMERGENCY**

Municipality: \_\_\_\_\_

**Section 18(2) of the *Emergency Management Act*, S.N.S 1990, c.8**

**WHEREAS** by Declaration of a State of Local Emergency date the \_\_\_\_\_ day of \_\_\_\_\_, 20\_\_\_\_, as renewed on the \_\_\_\_\_ day of \_\_\_\_\_, 20\_\_\_\_, a State of Local Emergency was declared for the following area:

**Emergency Area:**

The area generally described as

\_\_\_\_\_

Province of Nova Scotia (hereafter referred to as the "Designated Area(s)") Yes (  ) No (  )

**Nature of the Emergency**

\_\_\_\_\_  
\_\_\_\_\_  
\_\_\_\_\_

**AND WHEREAS** the undersigned is of the opinion that the emergency no longer exists in the Designated Area(s).

**THE UNDERSIGNED** pursuant to Section 18(2) of Chapter 8 of the Statutes of Nova Scotia, 1990, the *Emergency Management Act*, hereby terminates the State of Local Emergency effective as of and from \_\_\_\_\_ o'clock in the forenoon (  ) or afternoon (  ) of the day of \_\_\_\_\_, 20\_\_\_\_.

DATED at \_\_\_\_\_, in the Municipality of \_\_\_\_\_, Province of Nova Scotia, this day of \_\_\_\_\_, 20\_\_\_\_.

Council of Municipality \_\_\_\_\_

Name \_\_\_\_\_

Positions \_\_\_\_\_

[Authorized by Resolution No. \_\_\_\_\_

dated the Day of \_\_\_\_\_, 20\_\_\_\_]

## Annex I – Important Numbers

NSP Power Outage  
**1-877-428-6004**

Forest Fires/Poaching/Wildlife Emergencies  
**1-800-565-2224**

Bell Aliant Outage  
**611 or 1-800-663-2600**

Transportation and Renewal  
**1-844-696-7737**

Eastlink Outage  
**1-888-345-1111**

Environmental Emergencies (oil spills and gas leaks)  
**1-800-565-1633**

Drinking Water Safety  
**1-877-252-8476**

Food Safety  
**1-877-252-3663**

Emergency Management Office (NS)  
**1-866-424-5620**

Maritime Northeast Pipeline Emergency  
**1-888-444-6677**

Department of Environment  
 Truro Office **902-893-5880**

Department of Lands & Forestry  
 Bible Hill Office **902-893-5620**

EMO (NS) Region 2 EMPO		
Region 2 (Cumberland, Colchester, East Hants, Pictou, Antigonish, Guysborough)	<b>Dominic Fewer</b>	902-897-8152 <a href="mailto:dominic.fewer@novascotia.ca">dominic.fewer@novascotia.ca</a>

Town of Truro Office  
**902-895-4484**  
 After Hours  
**902-895-5351**

Town of Stewiacke Office  
**902-639-2231**  
 After Hours  
**902-897-7823**

Municipality of Colchester  
**902-897-3150**  
 After Hours  
**902-897-3160**

**911** - This is for emergencies only. If someone’s health, safety, and/or property are threatened, and help is needed right away.

**811** - For health information and advice when you have a health concern or question.

**511** - For information about Provincial roads in Nova Scotia.

**211** - For community and social services.